

Slewing tower crane

WOLFF 8033.16 cross

Technical information

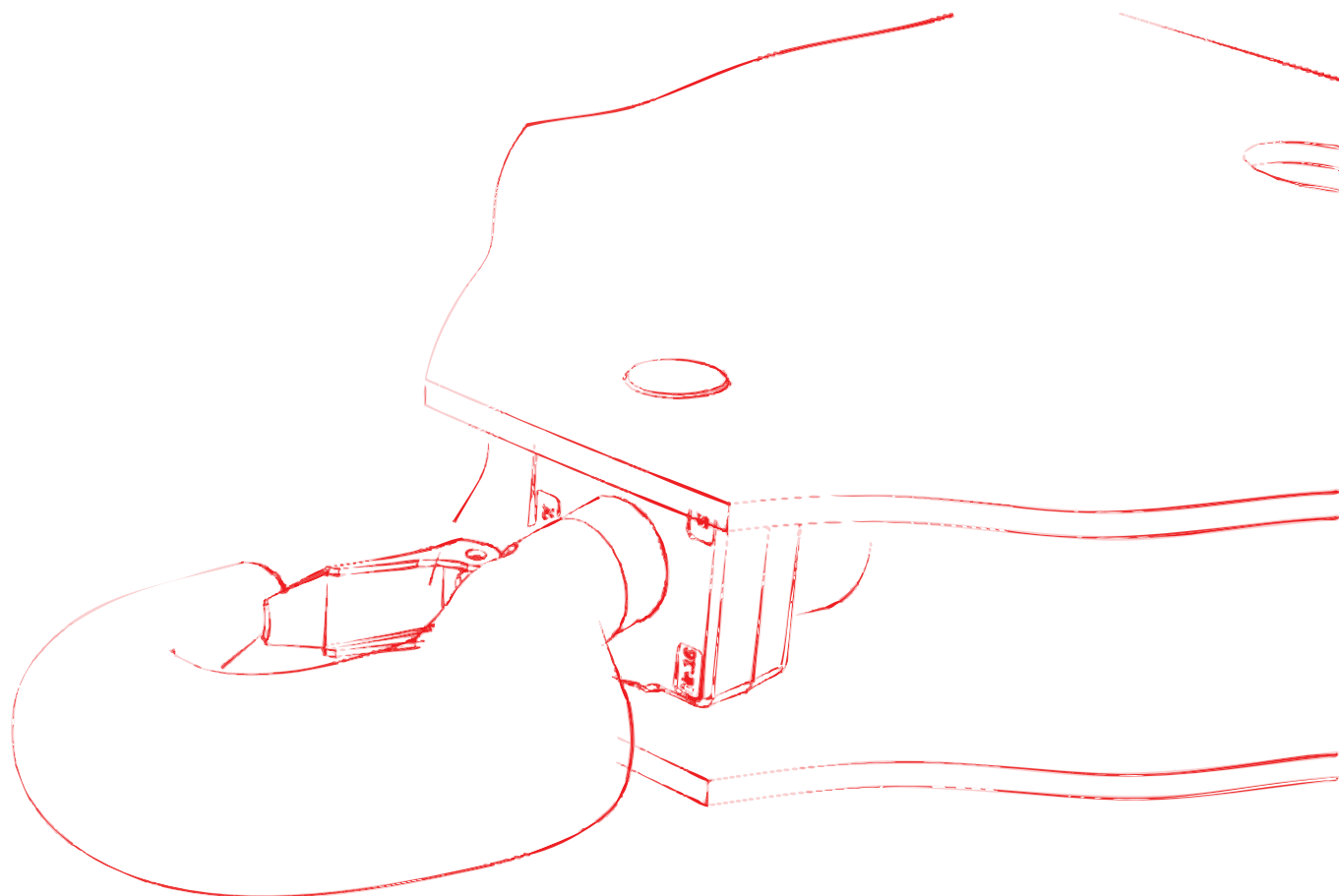

English

English



Published by

WOLFFKRAN GmbH

Austraße 72

74076 Heilbronn

Germany

Phone +49 7131 9815 0

Fax +49 7131 9815 355

www.wolffkran.com

info@wolffkran.de

Copyright

This documentation including all of its subsections is protected by copyright laws.

Any type of use or modification outside of the stringent limits of the copyright laws without permission of WOLFFKRAN GmbH is prohibited and subject to penalties.

This applies particularly for copying, translation, microfilming and storage and processing in electronic systems.

At the time of printing, the information, data, illustrations and notes comprised in this manual were up-to-date.

Subject to change of design, error and typos.

Stand: 03/2017

Table of contents

1	Schedule drawing	7
1.1	Schedule drawing WOLFF 8033.8cross	7
1.2	Schedule drawing WOLFF 8033.16cross	8
2	Load carrying capacities	9
2.1	Table of load carrying capacity WOLFF 8033.8 (2 fall operation)	10
2.2	Table of load carrying capacities (kg) in meter intervals, WOLFF 8033.8 (8.5 t, 2 fall operation)	11
2.3	Table of load carrying capacity WOLFF 8033.16 (2 fall operation)	12
2.4	Table of load carrying capacities (kg) in meter intervals, WOLFF 8033.16 (8.3 t, 2 fall operation mode)	13
2.5	Table of load carrying capacity WOLFF 8033.16 (4-fall mode)	14
2.6	Table of load carrying capacities (kg) in meter intervals, WOLFF 8033.16 (16,5 t, 4-fall mode)	15
3	Tower combinations	16
3.1	Tower combinations on foundation (slewing section with TV 20 - connection)	17
3.2	Tower combinations on foundation (slewing section with HT 23 - connection)	22
3.3	Tower combinations on cross frame (slewing section with TV 20 - connection)	23
3.4	Tower combinations on cross frame element (slewing section with TV 20 - connection)	29
3.5	Tower combinations on mobile cross frame (slewing section with TV 20 - connection)	31
3.6	Tower combinations on undercarriage (slewing section with TV 20 - connection)	36
4	Foundation loads / central ballast weights / corner loads in compliance with EN 14439 / EN 13001	38
4.1	Foundation loads jib 30 m - 80 m (TV 20 - connection)	40
4.2	Foundation loads jib 30 m - 80 m (HT 23 - connection)	41
5	Operating speeds	42
6	Package list	45
6.1	Package list 8033.8	45
6.2	Package list 8033.16	47
7	Assembly weights	49
7.1	Counterweight blocks	49

7.1.1	Counterweight block, 2.7 t	50
7.1.2	Counterweight block, 3.0 t	51
7.2	Total weight jib assembly	52
7.3	Assembly weight slewing section	54
7.4	Assembly weight cross frame	56
7.5	Assembly weights traveling cross frame	57
7.6	Assembly weight cross frame elements	58
7.7	Assembly weight undercarriage	59
7.8	Required hook height for mobile cranes	60
8	Assembly diagrams	62
8.1	Jib attachment diagram	62
8.1.1	Trolley jib - attachment diagram 8033.8	63
8.1.1.1	Trolley jib - attachment diagram 80.0 m to 75.0 m	63
8.1.1.2	Trolley jib - attachment diagram 72.5 m to 67.5 m	64
8.1.1.3	Trolley jib - attachment diagram 65.0 m to 60.0 m	65
8.1.1.4	Trolley jib - attachment diagram 57.5 m to 52.5 m	66
8.1.1.5	Trolley jib - attachment diagram 50.0 m to 45.0 m	67
8.1.1.6	Trolley jib - attachment diagram 42.5 m to 37.5 m	68
8.1.1.7	Trolley jib - attachment diagram 35.0 m to 30.0 m	69
8.1.2	Trolley jib - attachment diagram 8033.16	70
8.1.2.1	Trolley jib - attachment diagram 80.0 m to 75.0 m	70
8.1.2.2	Trolley jib - attachment diagram 72.5 m to 67.5 m	71
8.1.2.3	Trolley jib - attachment diagram 65.0 m to 60.0 m	72
8.1.2.4	Trolley jib - attachment diagram 57.5 m to 52.5 m	73
8.1.2.5	Trolley jib - attachment diagram 50.0 m to 45.0 m	74
8.1.2.6	Trolley jib - attachment diagram 42.5 m to 37.5 m	75
8.1.2.7	Trolley jib - attachment diagram 35.0 m to 30.0 m	76
8.2	Jib brace diagram	77
8.3	Trolley jib mounting rig	79
8.4	Arrangement of standard railings	80
8.4.1	Standard railings (NG) and accessories	80
8.4.2	Arrangement of standard railings	81
9	Suitable climbing devices	84
9.1	Outer climbing devices	85
9.1.1	Outer climbing device KWH 20.6 / KWH 20.6.1 / KWH 20.6.2	86

9.1.2	Outer climbing device KWH 23 / KWH 23.1	88
9.2	Inner climbing devices	92
9.2.1	Inner climbing device KSH 20 SH	93
9.2.2	Inner climbing device KSH 23/ KSH E 23	97
10	Arrangement of counterweight blocks	103

1 Schedule drawing

1.1 Schedule drawing WOLFF 8033.8cross

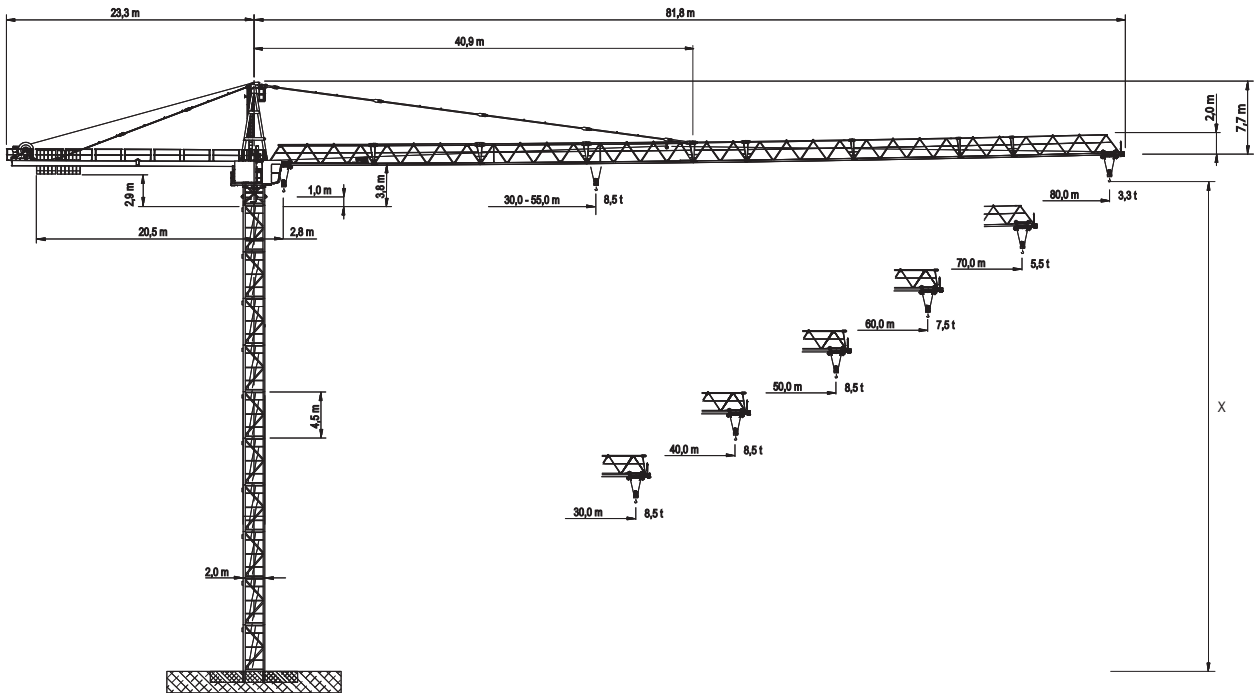

[X] max. hook height above ground

Data WOLFF 8033.8

Item	Data
Crane type	BGL GROUP C.0.10.0450
Design	Overhead travelling crane with top slewing trolley jib, with climbing feature
Type of setup	Stationary or travelling
Basis of calculation	EN
Payload torque	max. 4680 kNm
Hoist winch	Hw 875 FU

1 Schedule drawing

1.2 Schedule drawing WOLFF 8033.16cross

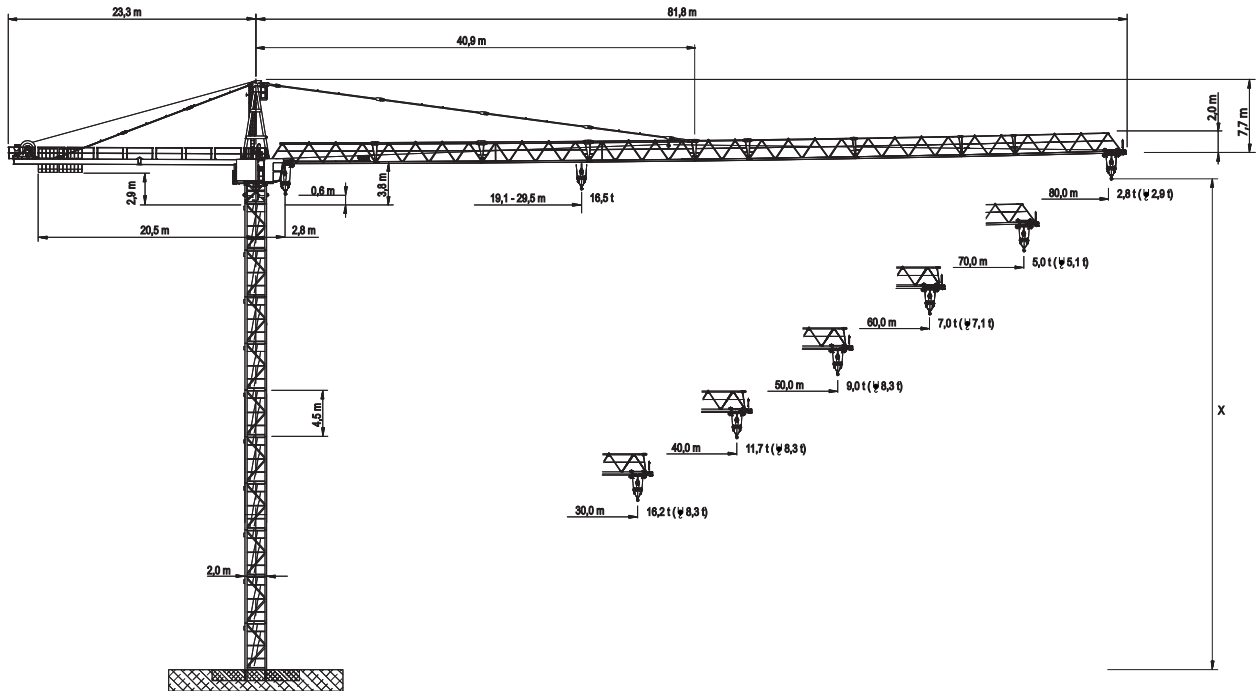

[X] max. hook height above ground

Data WOLFF 8033.16

Item	Data
Crane type	BGL GROUP C.0.10.0450
Design	Overhead travelling crane with top slewing trolley jib, with climbing feature
Type of setup	Stationary or travelling
Basis of calculation	EN
Payload torque	max. 4870 kNm
Hoist winch	Hw 875 FU

2 Load carrying capacities



NOTICE

WOLFF-Boost

With the WOLFF-Boost function, the load is allowed to exceed the load torque range specified for the lifting capacities by up to 10%. This is, however, subject to the restriction that hoisting gear and trolley drive (trolley crane) respectively hoisting gear and derricking gear (luffing crane) must only be moved alternately.

2 Load carrying capacities

2.1 Table of load carrying capacity WOLFF 8033.8 (2 fall operation)

 8.5 t		Operating radius [m]	Operating radius [m]												LCC
			30	35	40	45	50	55	60	65	70	75	80		
JL [m]	80	2.8 – 36.2	8.5	8.5	7.6	6.6	5.9	5.3	4.7	4.3	3.9	3.6	3.3	LCC [t]	
	77.5	2.8 – 39.9	8.5	8.5	8.5	7.4	6.6	5.9	5.3	4.8	4.4	4.1			
	75	2.8 – 43.4	8.5	8.5	8.5	8.2	7.3	6.5	5.9	5.3	4.9	4.5			
	72.5	2.8 – 45.8	8.5	8.5	8.5	8.5	7.7	6.9	6.3	5.7	5.2				
	70	2.8 – 47.9	8.5	8.5	8.5	8.5	8.1	7.3	6.6	6.0	5.5				
	67.5	2.8 – 49.7	8.5	8.5	8.5	8.5	8.5	7.6	6.9	6.3					
	65	2.8 – 51.3	8.5	8.5	8.5	8.5	8.5	7.9	7.1	6.5					
	62.5	2.8 – 56.6	8.5	8.5	8.5	8.5	8.5	8.1	7.3						
	60	2.8 – 53.7	8.5	8.5	8.5	8.5	8.5	8.3	7.5						
	57.5	2.8 – 54.5	8.5	8.5	8.5	8.5	8.5	8.4							
	55	2.8 – 55.0	8.5	8.5	8.5	8.5	8.5	8.5							
	52.5	2.8 – 52.5	8.5	8.5	8.5	8.5	8.5								
	50	2.8 – 50.0	8.5	8.5	8.5	8.5	8.5								
	47.5	2.8 – 47.5	8.5	8.5	8.5	8.5									
	45	2.8 – 45.0	8.5	8.5	8.5	8.5									
	42.5	2.8 – 45.5	8.5	8.5	8.5										
	40	2.8 – 40.0	8.5	8.5	8.5										
	37.5	2.8 – 37.5	8.5	8.5											
	35	2.8 – 35.0	8.5	8.5											
	32.5	2.8 – 32.5	8.5												
30	2.8 – 30.0	8.5													

Caption

JL	Jib length
LCC	Load carrying capacity

The load carrying capacity is related to a hook range of 42.0 m. Hook ranges greater than that reduce the maximum load carrying capacity by the weight of the additional hoisting ropes (2 fall operation = 2.52 kg per meter of the hook range).

2 Load carrying capacities

2.3 Table of load carrying capacity WOLFF 8033.16 (2 fall operation)

 8.3 t		Operating radius [m]	Operating radius [m]												LCC
			30	35	40	45	50	55	60	65	70	75	80		
JL [m]	80	2.8 – 35.4	8.3	8.3	7.2	6.2	5.5	4.9	4.3	3.9	3.5	3.2	2.9	LCC [t]	
	77.5	2.8 – 39.1	8.3	8.3	8.1	7.0	6.2	5.5	4.9	4.4	4.0	3.7			
	75	2.8 – 42.5	8.3	8.3	8.3	7.8	6.9	6.1	5.5	4.9	4.5	4.1			
	72.5	2.8 – 44.8	8.3	8.3	8.3	8.3	7.3	6.5	5.9	5.3	4.8				
	70	2.8 – 46.9	8.3	8.3	8.3	8.3	7.7	6.9	6.2	5.6	5.1				
	67.5	2.8 – 48.7	8.3	8.3	8.3	8.3	8.1	7.2	6.5	5.9					
	65	2.8 – 50.2	8.3	8.3	8.3	8.3	8.3	7.5	6.7	6.1					
	62.5	2.8 – 51.5	8.3	8.3	8.3	8.3	8.3	7.7	6.9						
	60	2.8 – 52.6	8.3	8.3	8.3	8.3	8.3	7.9	7.1						
	57.5	2.8 – 53.4	8.3	8.3	8.3	8.3	8.3	8.0							
	55	2.8 – 53.9	8.3	8.3	8.3	8.3	8.3	8.1							
	52.5	2.8 – 52.5	8.3	8.3	8.3	8.3	8.3								
	50	2.8 – 50.0	8.3	8.3	8.3	8.3	8.3								
	47.5	2.8 – 47.5	8.3	8.3	8.3	8.3									
	45	2.8 – 45.0	8.3	8.3	8.3	8.3									
	42.5	2.8 – 42.5	8.3	8.3	8.3										
	40	2.8 – 40.0	8.3	8.3	8.3										
	37.5	2.8 – 37.5	8.3	8.3											
	35	2.8 – 35.0	8.3	8.3											
	32.5	2.8 – 32.5	8.3												
30	2.8 – 30.0	8.3													

Caption

JL	Jib length
LCC	Load carrying capacity

The load carrying capacity is related to a hook range of 42.0 m. Hook ranges greater than that reduce the maximum load carrying capacity by the weight of the additional hoisting ropes (2 fall operation = 2.52 kg per meter of the hook range).

2 Load carrying capacities

2.5 Table of load carrying capacity WOLFF 8033.16 (4-fall mode)

 16.5 t		Operating radius [m]	Operating radius [m]												LCC [t]
			30	35	40	45	50	55	60	65	70	75	80		
JL [m]	80	2.8 – 19.1	10.0	8.3	7.1	6.1	5.4	4.8	4.2	3.8	3.4	3.1	2.8		
	77.5	2.8 – 21.1	11.1	9.3	8.0	6.9	6.1	5.4	4.8	4.3	3.9	3.6			
	75	2.8 – 22.9	12.2	10.3	8.8	7.7	6.8	6.0	5.4	4.8	4.4	4.0			
	72.5	2.8 – 24.1	13.0	10.9	9.4	8.2	7.2	6.4	5.8	5.2	4.7				
	70	2.8 – 25.3	13.7	11.5	9.9	8.6	7.6	6.8	6.1	5.5	5.0				
	67.5	2.8 – 26.2	14.2	12.0	10.3	9.0	8.0	7.1	6.4	5.8					
	65	2.8 – 27.1	14.7	12.4	10.7	9.3	8.3	7.4	6.6	6.0					
	62.5	2.8 – 27.8	15.2	12.8	11.0	9.6	8.5	7.6	6.8						
	60	2.8 – 28.3	15.5	13.1	11.3	9.8	8.7	7.8	7.0						
	57.5	2.8 – 28.7	15.7	13.3	11.4	10.0	8.9	7.9							
	55	2.8 – 29.0	15.9	13.4	11.6	10.1	9.0	8.0							
	52.5	2.8 – 29.2	16.0	13.5	11.6	10.2	9.0								
	50	2.8 – 29.2	16.0	13.5	11.6	10.2	9.0								
	47.5	2.8 – 29.3	16.1	13.6	11.7	10.2									
	45	2.8 – 29.2	16.1	13.5	11.7	10.2									
	42.5	2.8 – 29.3	16.1	13.6	11.7										
	40	2.8 – 29.3	16.1	13.6	11.7										
	37.5	2.8 – 29.4	16.1	13.6											
	35	2.8 – 29.4	16.1	13.6											
	32.5	2.8 – 29.4	16.2												
30	2.8 – 29.5	16.2													



Caption

JL	Jib length
LCC	Load carrying capacity

The load carrying capacity is related to a hook range of 42.0 m. Hook ranges greater than that reduce the maximum load carrying capacity by the weight of the additional hoisting ropes (4 fall operation = 5.04 kg per meter of the hook range).

3 Tower combinations

3 Tower combinations

	<p style="text-align: center;">! DANGER</p> <p>Usage of incorrect tower combinations. The slewing tower crane may overturn.</p> <ol style="list-style-type: none">1) Use the specified tower combinations.2) If you need another tower combination that is not specified here, please contact WOLFFKRAN to get an approved alternative setup in writing.
	<p style="text-align: center;">NOTICE</p> <p>All tower combinations apply to free standing slewing tower cranes without climbing gear.</p>
	<p style="text-align: center;">NOTICE</p> <p>The 4 fall hook height is only for the crane 8033.16 in 4 fall operation.</p>

3.1 Tower combinations on foundation (slewing section with TV 20 - connection)

Jib length	30 m – 80 m			
Item				
1	4.5 m	TV 20.4		
2	9.0 m	TV 20.4		
3	13.5 m	TV 20.4		
4	18.0 m	TV 20.4		
5	22.5 m	TV 20.4		
6	27.0 m	TV 20.4		
7	31.5 m	TV 20.4		
8	36.0 m	TV 20.4		
9	40.5 m	TV 20.4		
10	45.0 m	TV 20.4		
11	49.5 m	TV 20.4		
12	54.0 m	TV 20.4		
Foundation anchors		TYPE D 140/ FUA 140		
Tower height [m]		54.0		
Hook height double reeving [m]		55.0		
Hook height 4 fall operation [m]		54.6		
Wind category		C25		

3 Tower combinations

Jib length	30 m – 80 m			
Item				
1	4.5 m	TV 20.4		
2	9.0 m	TV 20.4		
3	13.5 m	TV 20.4		
4	18.0 m	TV 20.4		
5	22.5 m	TV 20.4		
6	27.0 m	TV 20.4		
7	31.5 m	TV 20.4		
8	36.0 m	TV 20.4		
9	40.5 m	TV 20.4		
10	45.0 m	TV 20.4		
11	49.5 m	TV 20.4		
12	50.5 m	VR 2023		
13	55.0 m	TV 23		
14	59.5 m	TV 23		
Foundation anchors		TYPE D-140 / FUA 140		
Tower height [m]		59.5		
Hook height double reeving [m]		60.5		
Hook height 4 fall operation [m]		60.1		
Wind category		C25		

Jib length	30 m – 80 m			
Item				
1	4.5 m	TV 20.4		
2	9.0 m	TV 20.4		
3	13.5 m	TV 20.4		
4	18.0 m	TV 20.4		
5	22.5 m	TV 20.4		
6	27.0 m	TV 20.4		
7	31.5 m	TV 20.4		
8	36.0 m	TV 20.4		
9	40.5 m	TV 20.4		
10	45.0 m	TV 20.4		
11	46.0 m	VR 2023		
12	50.5 m	TV 23		
13	55.0 m	TV 23		
14	59.5 m	HTA 23		
15	64.0 m	HT 23		
16	68.5 m	HT 23		
17	73.0 m	HT 23		
Foundation anchors		FUA G 160		
Tower height [m]		73.0		
Hook height double reeving [m]		74.0		
Hook height 4 fall operation [m]		73.6		
Wind category	C25			

3 Tower combinations

Jib length	30 m – 80 m				
Item					
1	4.5 m	TV 20.4			
2	9.0 m	TV 20.4			
3	13.5 m	TV 20.4			
4	18.0 m	TV 20.4			
5	22.5 m	TV 20.4			
6	27.0 m	TV 20.4			
7	31.5 m	TV 20.4			
8	36.0 m	TV 20.4			
9	40.5 m	TV 20.4			
10	41.5 m	VR 2023			
11	46.0 m	TV 23			
12	50.5 m	TV 23			
13	55.0 m	HTA 23			
14	59.5 m	HT 23			
15	64.0 m	HT 23			
16	68.5 m	HT 23			
17	79.8 m	BT 23			
Foundation anchors		FUA 210 G			
Tower height [m]		79.8			
Hook height double reeving [m]		80.8			
Hook height 4 fall operation [m]		80.4			
Wind category					C25

Jib length	30 m – 80 m			
Item				
1	4.5 m	TV 20.4		
2	9.0 m	TV 20.4		
3	13.5 m	TV 20.4		
4	18.0 m	TV 20.4		
5	22.5 m	TV 20.4		
6	27.0 m	TV 20.4		
7	31.5 m	TV 20.4		
8	36.0 m	TV 20.4		
9	40.5 m	TV 20.4		
10	41.5 m	VR 2023		
11	46.0 m	TV 23		
12	50.5 m	TV 23		
13	55.0 m	HTA 23		
14	59.5 m	HT 23		
15	64.0 m	HT 23		
16	68.5 m	HT 23		
17	69.7 m	VR 23/25-29		
18	74.2 m	UV 29		
19	84.2 m	BT 29		
Foundation anchors		FUA BT 29		
Tower height [m]		84.2		
Hook height double reeving [m]		85.2		
Hook height 4 fall operation [m]		84.8		
Wind category	C25			

3 Tower combinations

3.2 Tower combinations on foundation (slewing section with HT 23 - connection)

Jib length		30 m – 80 m			
Item					
1	4.5 m	HT 23			
2	9.0 m	HT 23			
3	13.5 m	HT 23			
4	18.0 m	HT 23			
5	22.5 m	HT 23			
6	27.0 m	HT 23			
7	31.5 m	HT 23			
8	36.0 m	HT 23			
9	40.5 m	HT 23			
10	45.0 m	HT 23			
11	49.5 m	HT 23			
12	54.0 m	HT 23			
13	58.5 m	HT 23			
14	63.0 m	HT 23			
15	67.5 m	HT 23			
16	78.8 m	BT 23			
Foundation anchors		FUA 210 G			
Tower height [m]		78.8			
Hook height double reeving [m]		79.8			
Hook height 4 fall operation [m]		79.4			
Wind category			C25		

3.3 Tower combinations on cross frame (slewing section with TV 20 - connection)

Jib length	30 m – 80 m			
Item				
1	4.5 m	TV 20.4		
2	9.0 m	TV 20.4		
3	13.5 m	TV 20.4		
4	18.0 m	TV 20.4		
5	22.5 m	TV 20.4		
6	27.0 m	TV 20.4		
7	31.5 m	TV 20.4		
8	36.0 m	TV 20.4		
9	40.5 m	TV 20.4		
10	45.0 m	TV 20.4		
11	49.5 m	TV 20.4		
12	54.0 m	TV 20.4		
Substructure		KR 12-60 / KR 12-60/80		
Corner distance [m x m]		6.0 x 6.0 8.0 x 8.0		
Substructure height [m]		1.4		
Tower height [m]		55.4		
Hook height double reeving [m]		56.4		
Hook height 4 fall operation [m]		56.0		
Wind category		C25		

3 Tower combinations

Jib length	30 m – 80 m			
Item				
1	4.5 m	TV 20.4		
2	9.0 m	TV 20.4		
3	13.5 m	TV 20.4		
4	18.0 m	TV 20.4		
5	22.5 m	TV 20.4		
6	27.0 m	TV 20.4		
7	31.5 m	TV 20.4		
8	36.0 m	TV 20.4		
9	40.5 m	TV 20.4		
10	45.0 m	TV 20.4		
11	49.5 m	TV 20.4		
12	50.5 m	VR 2023		
13	55.0 m	TV 23		
14	59.5 m	TV 23		
Substructure		KR 12-60 / KR 12-60/80		
Corner distance [m x m]		6.0 x 6.0 8.0 x 8.0		
Substructure height [m]		1.4		
Tower height [m]		60.9		
Hook height double reeving [m]		61.9		
Hook height 4 fall operation [m]		61.5		
Wind category	C25			

Jib length	30 m – 80 m			
Item				
1	4.5 m	TV 20.4		
2	9.0 m	TV 20.4		
3	13.5 m	TV 20.4		
4	18.0 m	TV 20.4		
5	22.5 m	TV 20.4		
6	27.0 m	TV 20.4		
7	31.5 m	TV 20.4		
8	36.0 m	TV 20.4		
9	40.5 m	TV 20.4		
10	45.0 m	TV 20.4		
11	46.0 m	VR 2023		
12	50.5 m	TV 23		
13	55.0 m	TV 23		
14	59.5 m	HTA 23		
15	64.0 m	HT 23		
16	68.5 m	HT 23		
Substructure		KR 12-60 / KR 12-60/80		
Corner distance [m x m]		6.0 x 6.0 8.0 x 8.0		
Substructure height [m]		1.4		
Tower height [m]		69.9		
Hook height double reeving [m]		70.9		
Hook height 4 fall operation [m]		70.5		
Wind category	C25			

3 Tower combinations

Jib length	30 m – 80 m				
Item					
1	4.5 m	TV 20.4			
2	9.0 m	TV 20.4			
3	13.5 m	TV 20.4			
4	18.0 m	TV 20.4			
5	22.5 m	TV 20.4			
6	27.0 m	TV 20.4			
7	31.5 m	TV 20.4			
8	36.0 m	TV 20.4			
9	40.5 m	TV 20.4			
10	45.0 m	TV 20.4			
11	46.0 m	VR 2023			
12	50.5 m	TV 23			
13	55.0 m	TV 23			
14	59.5 m	HTA 23			
15	64.0 m	HT 23			
16	68.5 m	HT 23			
Substructure		KR 16-80 / KR 16-80/100			
Corner distance [m x m]		8.0 x 8.0 10.0 x 10.0			
Substructure height [m]		1.8			
Tower height [m]		70.3			
Hook height double reeving [m]		71.3			
Hook height 4 fall operation [m]		70.9			
Wind category	C25				

Jib length	30 m – 80 m			
Item				
1	4.5 m	TV 20.4		
2	9.0 m	TV 20.4		
3	13.5 m	TV 20.4		
4	18.0 m	TV 20.4		
5	22.5 m	TV 20.4		
6	27.0 m	TV 20.4		
7	31.5 m	TV 20.4		
8	36.0 m	TV 20.4		
9	40.5 m	TV 20.4		
10	41.5 m	VR 2023		
11	46.0 m	TV 23		
12	50.5 m	TV 23		
13	55.0 m	HTA 23		
14	59.5 m	HT 23		
15	64.0 m	HT 23		
16	68.5 m	HT 23		
17	69.7 m	VR 23/25-29		
18	79.7 m	BT 29		
Substructure		KR 16-80		
Corner distance [m x m]		8.0 x 8.0		
Substructure height [m]		1.8		
Tower height [m]		81.5		
Hook height double reeving [m]		82.5		
Hook height 4 fall operation [m]		82.1		
Wind category	C25			

3 Tower combinations

Jib length	30 m – 80 m			
Item				
1	4.5 m	TV 20.4		
2	9.0 m	TV 20.4		
3	13.5 m	TV 20.4		
4	18.0 m	TV 20.4		
5	22.5 m	TV 20.4		
6	27.0 m	TV 20.4		
7	31.5 m	TV 20.4		
8	36.0 m	TV 20.4		
9	40.5 m	TV 20.4		
10	41.5 m	VR 2023		
11	46.0 m	TV 23		
12	50.5 m	TV 23		
13	55.0 m	HTA 23		
14	59.5 m	HT 23		
15	64.0 m	HT 23		
16	68.5 m	HT 23		
17	69.7 m	VR 23/25-29		
18	74.2 m	UV 29		
19	84.2 m	BT 29		
Substructure		KR 16-80/100		
Corner distance [m x m]		10.0 x 10.0		
Substructure height [m]		1.8		
Tower height [m]		86.0		
Hook height double reeving [m]		87.0		
Hook height 4 fall operation [m]		86.6		
Wind category			C25	

3.4 Tower combinations on cross frame element (slewing section with TV 20 - connection)

Jib length	30 m – 80 m			
Item				
1	4.5 m	TV 20.4		
2	9.0 m	TV 20.4		
3	13.5 m	TV 20.4		
4	18.0 m	TV 20.4		
5	22.5 m	TV 20.4		
6	27.0 m	TV 20.4		
Substructure		KRE 260.2		
Corner distance [m x m]		6.0 x 6.0		
Substructure height [m]		4.0		
Tower height [m]		31.0		
Hook height double reeving [m]		32.0		
Hook height 4 fall operation [m]		31.6		
Wind category		C25		

3 Tower combinations

Jib length	30 m – 80 m				
Item					
1	4.5 m	TV 20.4			
2	9.0 m	TV 20.4			
3	13.5 m	TV 20.4			
4	18.0 m	TV 20.4			
5	22.5 m	TV 20.4			
6	27.0 m	TV 20.4			
7	31.5 m	TV 20.4			
8	36.0 m	TV 20.4			
9	40.5 m	TV 20.4			
10	45.0 m	TV 20.4			
11	49.5 m	TVÜ 20.4			
12	54.0 m	UVA 25			
Substructure		KRE 480			
Corner distance [m x m]		8.0 x 8.0			
Substructure height [m]		4.0			
Tower height [m]		58.0			
Hook height double reeving [m]		59.0			
Hook height 4 fall operation [m]		58.6			
Wind category		C25			

3.5 Tower combinations on mobile cross frame (slewing section with TV 20 - connection)

Jib length	30 m – 80 m			
Item				
1	4.5 m	TV 20.4	TV 20.4	
2	9.0 m	TV 20.4	TV 20.4	
3	13.5 m	TV 20.4	TV 20.4	
4	18.0 m	TV 20.4	TV 20.4	
5	22.5 m	TV 20.4	TV 20.4	
6	27.0 m	TV 20.4	TV 20.4	
7	31.5 m	TV 20.4	TV 20.4	
8	36.0 m	TV 20.4	TV 20.4	
9	40.5 m	TV 20.4	TV 20.4	
10	45.0 m	TV 20.4	TV 20.4	
Substructure		KRF4 12-60/80	KRF6 12-60/80	
Corner distance [m x m]		8.0 x 8.0	8.0 x 8.0	
Substructure height [m]		2.5	2.9	
Tower height [m]		47.5	47.9	
Hook height double reeving [m]		48.5	48.9	
Hook height 4 fall operation [m]		48.1	48.5	
Wind category		C25		

3 Tower combinations

Jib length	30 m – 80 m				
Item					
1	4.5 m	TV 20.4	TV 20.4		
2	9.0 m	TV 20.4	TV 20.4		
3	13.5 m	TV 20.4	TV 20.4		
4	18.0 m	TV 20.4	TV 20.4		
5	22.5 m	TV 20.4	TV 20.4		
6	27.0 m	TV 20.4	TV 20.4		
7	31.5 m	TV 20.4	TV 20.4		
8	36.0 m	TV 20.4	TV 20.4		
9	40.5 m	TV 20.4	TV 20.4		
10	41.5 m	VR 2023	VR 2023		
11	46.0 m	TV 23	TV 23		
12	50.5 m	TV 23	TV 23		
13	55.0 m	TV 23	TV 23		
Substructure		KRF4 12-60/80	KRF6 12-60/80		
Corner distance [m x m]		8.0 x 8.0	8.0 x 8.0		
Substructure height [m]		2.5	2.9		
Tower height [m]		57.5	57.9		
Hook height double reeving [m]		58.5	58.9		
Hook height 4 fall operation [m]		58.1	58.5		
Wind category		C25			

Jib length	30 m – 80 m			
Item				
1	4.5 m	TV 20.4		
2	9.0 m	TV 20.4		
3	13.5 m	TV 20.4		
4	18.0 m	TV 20.4		
5	22.5 m	TV 20.4		
6	27.0 m	TV 20.4		
7	31.5 m	TV 20.4		
8	36.0 m	TV 20.4		
9	40.5 m	TV 20.4		
10	41.5 m	VR 2023		
11	46.0 m	TV 23		
12	50.5 m	TV 23		
13	55.0 m	HTA 23		
14	59.5 m	HT 23		
15	64.0 m	HT 23		
Substructure		KRF6 12-60/80		
Corner distance [m x m]		8.0 x 8.0		
Substructure height [m]		2.9		
Tower height [m]		66.9		
Hook height double reeving [m]		67.9		
Hook height 4 fall operation [m]		67.5		
Wind category	C25			

3 Tower combinations

Jib length	30 m – 80 m			
Item				
1	4.5 m	TV 20.4		
2	9.0 m	TV 20.4		
3	13.5 m	TV 20.4		
4	18.0 m	TV 20.4		
5	22.5 m	TV 20.4		
6	27.0 m	TV 20.4		
7	31.5 m	TV 20.4		
8	36.0 m	TV 20.4		
9	37.0 m	VR 2023		
10	41.5 m	TV 23		
11	46.0 m	TV 23		
12	50.5 m	HTA 23		
13	55.0 m	HT 23		
14	59.5 m	HT 23		
15	64.0 m	HT 23		
16	68.5 m	HT 23		
Substructure		KRF 16-80/100		
Corner distance [m x m]		10.0 x 10.0		
Substructure height [m]		3.3		
Tower height [m]		71.8		
Hook height double reeving [m]		72.8		
Hook height 4 fall operation [m]		72.4		
Wind category			C25	

Jib length		30 m – 80 m			
Item					
1	4.5 m	TV 20.4			
2	9.0 m	TV 20.4			
3	13.5 m	TV 20.4			
4	18.0 m	TV 20.4			
5	22.5 m	TV 20.4			
6	27.0 m	TV 20.4			
7	31.5 m	TV 20.4			
8	36.0 m	TV 20.4			
9	37.0 m	VR 2023			
10	41.5 m	TV 23			
11	46.0 m	TV 23			
12	50.5 m	HTA 23			
13	55.0 m	HT 23			
14	59.5 m	HT 23			
15	64.0 m	HT 23			
16	65.2 m	VR 23/25-29			
17	69.7 m	UV 29			
18	78.7 m	BT 29			
Substructure		KRF 16-80/100			
Corner distance [m x m]		10.0 x 10.0			
Substructure height [m]		3.3			
Tower height [m]		83.0			
Hook height double reeving [m]		84.0			
Hook height 4 fall operation [m]		83.6			
Wind category			C25		

3 Tower combinations



3.6 Tower combinations on undercarriage (slewing section with TV 20 - connection)

Jib length	30 m – 80 m				
Item					
1	4.5 m	TV 20.4			
2	9.0 m	TV 20.4			
3	13.5 m	TV 20.4			
4	18.0 m	TV 20.4			
5	22.5 m	TV 20.4			
Substructure		UW 260.3			
Corner distance [m x m]		6.0 x 6.0			
Substructure height [m]		4.5			
Tower height [m]		27.0			
Hook height double reeving [m]		28.0			
Hook height 4 fall operation [m]		27.6			
Wind category	C25				

Jib length	30 m – 80 m			
Item				
1	4.5 m	TV 20.4		
2	9.0 m	TV 20.4		
3	13.5 m	TV 20.4		
4	18.0 m	TV 20.4		
5	22.5 m	TV 20.4		
6	27.0 m	TV 20.4		
7	31.5 m	TV 20.4		
8	36.0 m	TV 20.4		
9	40.5 m	TV 20.4		
10	45.0 m	TVÜ 20.4		
11	49.5 m	TV 25		
12	54.0 m	UVA 25		
Substructure		UW 480		
Corner distance [m x m]		8.0 x 8.0		
Substructure height [m]		5.0		
Tower height [m]		59.0		
Hook height double reeving [m]		60.0		
Hook height 4 fall operation [m]		59.6		
Wind category		C25		

4 Foundation loads / central ballast weights / corner loads in compliance with EN 14439 / EN 13001

4 Foundation loads / central ballast weights / corner loads in compliance with EN 14439 / EN 13001

	<h2>⚠ DANGER</h2>
	<p>Usage of incorrect tower combinations. The slewing tower crane may overturn.</p> <ol style="list-style-type: none"> 1) Use the specified tower combinations. 2) If you need another tower combination that is not specified here, please contact WOLFFKRAN to get an approved alternative setup in writing.
	<h2>NOTICE</h2>
	<p>If you need foundation loads for tower combination with tower element TV 25 and UV 25, please contact WOLFFKRAN to get an approved alternative setup.</p>

Jib positions

The corner loads are given for two jib positions with the maximum corner load resulting from jib position 1.

For square setup, the following equation is true: $a = b$

For rectangular setup, the following equation is true: $a > b$

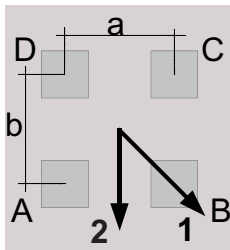

Cross frame or cross frame element

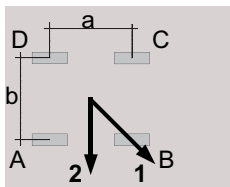

Undercarriage

NOTICE! For undercarriage details, please refer to the relevant operating manual.

Wind load with crane out of service

The stability for stormy weather is calculated on the basis of wind region C (EN 13001-2). The reference wind speed for zone C is 28 m/s (10 m above ground, averaged over 10 minutes). As a basis, a recurrence interval of 25 years is used. As a basis, a recurrence interval of 25 years is used.

4 Foundation loads / central ballast weights / corner loads in compliance with EN 14439 / EN 13001

Please contact WOLFFKRAN for stability calculations in other wind regions.

	<p data-bbox="794 320 1072 383">NOTICE</p> <p data-bbox="469 405 1386 468">The quadruple reeving hook height is only for the crane 8033.16 in quadruple reeving mode.</p>
---	--

For information on the different substructures, refer to Section 5 of the Operating Manual.

4.1 Foundation loads jib 30 m - 80 m (TV 20 - connection)

Slewing section 8033 cross with 30 m – 80 m jib on foundation.
Slewing tower crane without climbing device.

Foundation load in compliance with EN 14439 / EN 13001 – typical loads

Includes all dynamical factors under consideration of second-order theory for stationary slewing tower cranes on concrete foundation in compliance with a tower combination without climbing device.

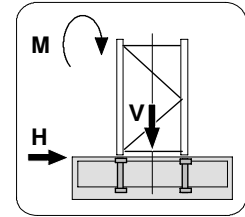

HH		Crane in service			Crane out of service			Assembly		
4	2	Slewing torque: 500 kNm			Wind category C25			M	V	H
STR	STR	M	V	H	M	V	H	M	V	H
[m]	[m]	[kNm]	[kN]	[kN]	[kNm]	[kN]	[kN]	[kNm]	[kN]	[kN]
5.1	5.5	3240	765	28	2670	595	45	3740	396	9
9.6	10.0	3380	793	30	2890	623	51	3790	424	10
14.1	14.5	3530	821	32	3140	651	57	3850	452	11
18.6	19.0	3700	850	34	3420	679	63	3910	481	12
23.1	23.5	3890	878	35	3750	708	69	3990	509	13
27.6	28.0	4100	906	37	4100	736	75	4070	537	15
32.1	32.5	4330	935	39	4500	764	82	4170	566	16
36.6	37.0	4730	1055	44	4940	793	88	4280	594	17
41.1	41.5	5030	1083	46	5430	821	94	4400	622	18
45.6	46.0	5370	1112	48	5960	849	100	4530	651	19
50.1	50.5	5830	1290	50	6550	878	106	4680	679	20
54.6	55.0	6280	1318	52	7190	906	112	5170	911	21
55.6	56.0	6290	1345	53	7280	933	116	5170	939	22
60.1	60.5	6740	1376	55	8680	1241	178	5370	969	23
64.6	65.0	7090	1432	58	9840	1297	191	5520	1025	24
69.1	69.5	7570	1471	60	11200	1337	203	5730	1064	25
73.6	74.0	8100	1510	62	12700	1376	215	5970	1104	27
75.9	76.3	8190	1556	64	13320	1422	223	6000	1150	28
80.4	80.8	8790	1596	66	15030	1461	236	6270	1189	29
Tower combination with base tower element BT 29										
80.3	80.7	8560	1609	66	14710	1475	237	6160	1202	29
84.8	85.2	9090	1655	69	16420	1521	251	6400	1249	30

Caption

HH:	Hook height	V:	Vertical load	STR:	Number of falls
H:	Horizontal load	M:	Torque		

4.2 Foundation loads jib 30 m - 80 m (HT 23 - connection)

Slewing section 8033 cross with 30 m – 80 m jib on foundation.
Slewing tower crane without climbing device.

Foundation load in compliance with EN 14439 / EN 13001 – typical loads

Includes all dynamical factors under consideration of second-order theory for stationary slewing tower cranes on concrete foundation in compliance with a tower combination without climbing device.

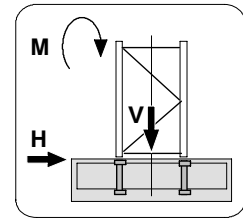



HH		Crane in service			Crane out of service			Assembly		
4	2	Slewing torque: 500 kNm			Wind category C25					
STR	STR	M	V	H	M	V	H	M	V	H
[m]	[m]	[kNm]	[kN]	[kN]	[kNm]	[kN]	[kN]	[kNm]	[kN]	[kN]
5.1	5.5	3240	776	28	2670	606	45	3740	407	9
9.6	10.0	3380	815	30	2890	645	53	3790	446	10
14.1	14.5	3530	855	32	3150	684	60	3840	486	12
18.6	19.0	3690	894	35	3440	724	67	3910	525	13
23.1	23.5	3950	1025	39	3770	763	74	3980	564	14
27.6	28.0	4160	1064	42	4140	803	81	4060	604	15
32.1	32.5	4390	1104	44	4540	842	88	4150	643	17
36.6	37.0	4640	1143	46	4990	881	95	4250	682	18
41.1	41.5	4910	1182	48	5480	921	102	4360	722	19
45.6	46.0	5200	1222	50	6010	960	109	4480	761	20
50.1	50.5	5520	1261	53	6590	999	116	4610	801	22
54.6	55.0	5870	1301	55	7220	1040	123	4990	1044	23
59.1	59.5	6240	1340	57	8590	1356	188	5170	1084	24
63.6	64.0	6760	1530	60	9870	1395	200	5370	1123	25
68.1	68.5	7240	1569	62	11280	1435	212	5590	1162	27
74.9	75.3	7950	1643	66	13520	1510	232	5910	1237	29
79.4	79.8	8550	1683	68	15290	1548	244	6180	1276	30

Caption

HH:	Hook height	V:	Vertical load	STR:	Number of falls
H:	Horizontal load	M:	Torque		

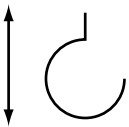
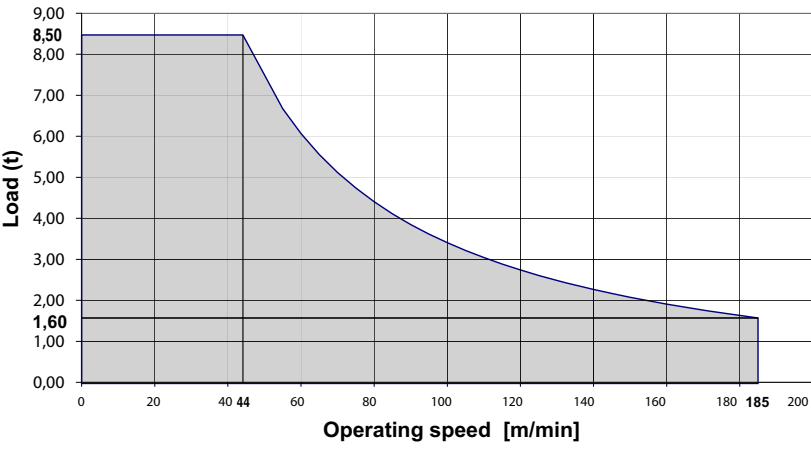
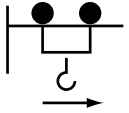
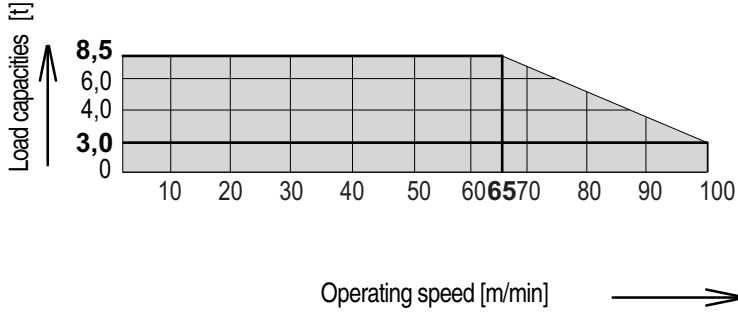

5 Operating speeds

5 Operating speeds

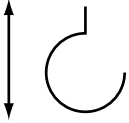
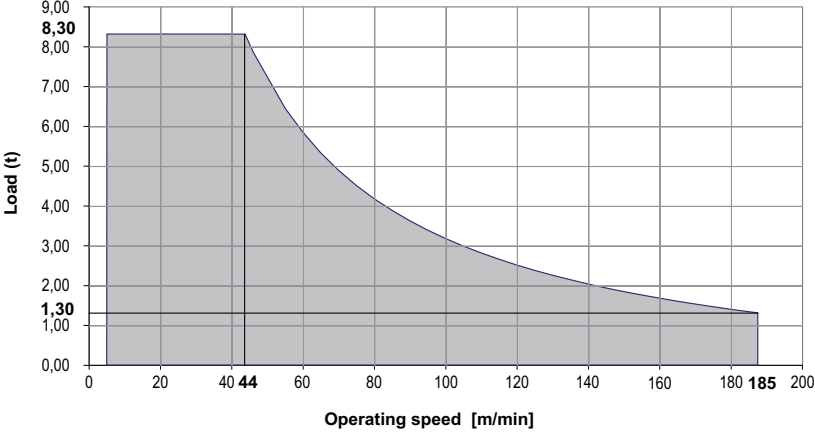
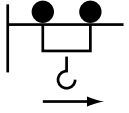
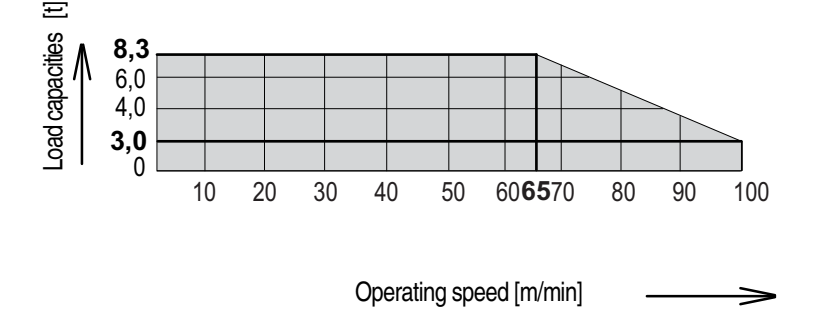

Drive unit [type]	Operating speed Carrying load		Hook travel distance max. [m]	Power [kW]	Total connected wattage [kVA]
Hw875FU	Lifting / lowering		400	75	97.0 Total connected load at coincidence factor of 0.7
					
KW	Trolley movement		9.0		
					
SG	Slewing		2 x 7.5		
					

	<h2>NOTICE</h2>
	<p>4 fall operation only with the 8033.16 cross. The 4 fall operation is only possible at the slewing tower crane 8033.16 cross.</p>

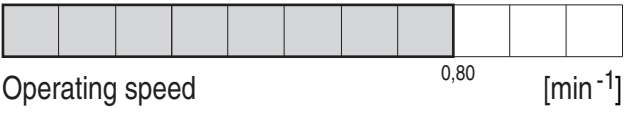
Operating speeds WOLFF 8033.16

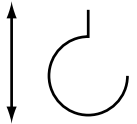
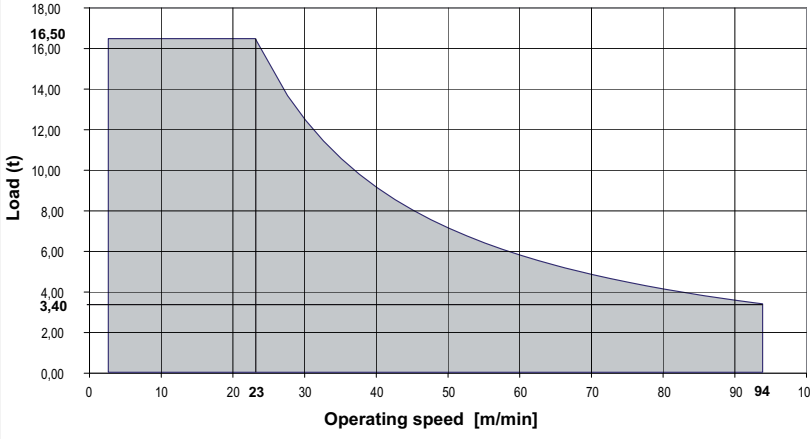
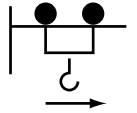
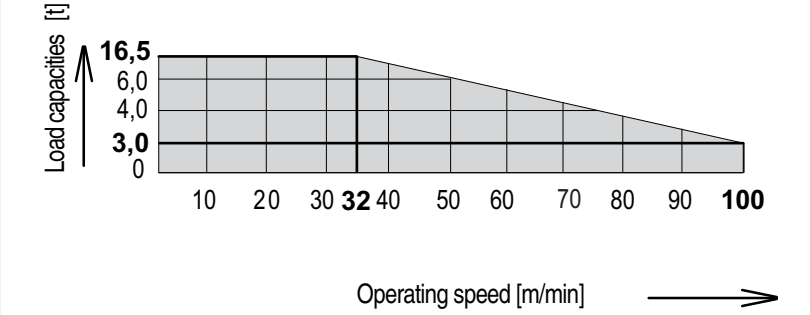

Drive unit [type]	Operating speed Carrying load	Hook travel distance max. [m]	Power [kW]	Total connected wattage [kVA]
Hw875FU	Lifting / lowering	 460	75	97.0
				
KW	Trolley movement	9.0		
				
SG	Slewing	2 x 7.5		
				

5 Operating speeds





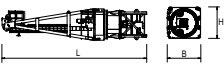
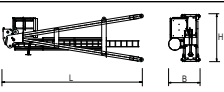
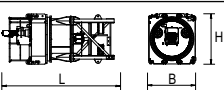
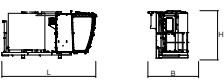

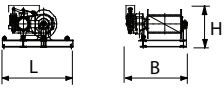
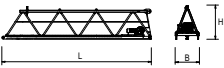
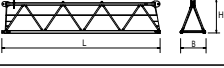
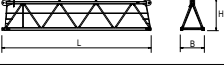



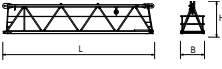

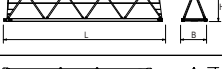
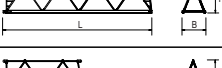
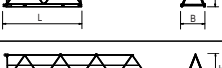
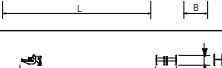
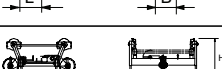
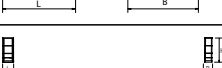
Drive unit [type]	Operating speed Carrying load		Hook travel distance max. [m]	Power [kW]	Total connected wattage [kVA]
Hw875FU	Lifting / lowering		230	75	97.0 Total connected load at coincidence factor of 0.7
					
KW	Trolley movement			9.0	
					
SG	Slewing			2 x 7.5	
					

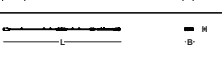
6 Package list

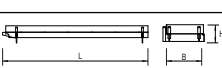
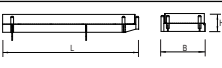
6.1 Package list 8033.8



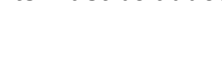

Quantity	Description	Package	L [m]	W [m]	H [m]	Weight [kg]	Volume [m ³]		
1	Tower head section, complete with slewing frame, ball race bearing, slewing gear and slip ring system (stay parts on counterjib)		with UV 20 lower part of tower head section					15000 (410)	66.41
			11.55	2.30	2.50				
			with HT 23 lower part of tower head section					16300 (410)	76.34
	Tower head section upper part (stay parts for counterjib)		7.39	2.49	1.66	2925 (410)	30.55		
	Tower head section lower part with slewing frame, ball race bearing, slewing gear and slip ring system		with UV 20 lower part of tower head section					12075	32.20
5.60			2.30	2.50					
with HT 23 lower part of tower head section					13370	37.68			
1	Driver's cab with driver's cab suspension and control cabinet		4.82	2.19	2.55	3030	26.92		
1	Counterjib in hinged position (stay parts on counterjib)		11.98	2.30	1.31	7140 (865)	36.10		
	Counterjib (stay parts on counterjib)		22.24	2.30	0.72	7140 (865)	36.83		
1	Hoist winch platform Hw875FU (2. Brake) (210 m hoist rope) (290m hoist rope)		2.17	1.88	1.18	2250 (270) (370)	4.82		
1	Jib element 1 with traverse gear		10.19	1.64	2.29	3400	38.54		
1	Jib element 2		10.19	1.64	2.08	2460	34.76		
1	Jib element 3		10.23	1.64	2.08	2320	34.90		

6 Package list



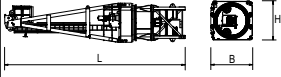
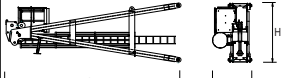
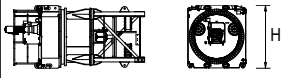

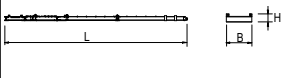

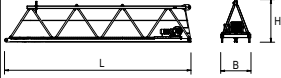
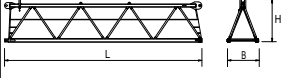
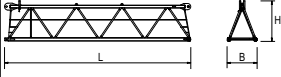
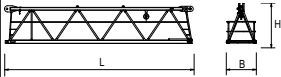





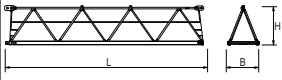
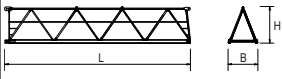

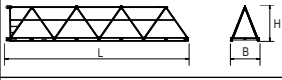
Quantity	Description	Package	L [m]	W [m]	H [m]	Weight [kg]	Volume [m ³]
1	Jib element 4		10.30	1.64	2.07	2300	34.97
1	Jib element 5		5.33	1.64	2.03	1135	17.74
1	Jib element 6		2.83	1.64	2.03	695	9.42
1	Jib element 7		10.28	1.64	2.03	1815	34.22
1	Jib element 8		10.22	1.64	2.02	1290	33.86
1	Jib element 9		5.20	1.64	2.01	660	17.14
1	Jib element 10		10.19	1.64	2.01	1040	33.59
1	Rope swivel crossbeam		1.38	1.54	0.50	245	1.06
1	Trolley LK 8		1.87	1.85	1.00	330	3.46
1	Maintenance cage		0.75	0.55	1.69	55	0.70
1	Hook block U 8		1.02	0.26	1.70	505	0.45
1	Brace rods for 80 m operating radius		10.17	0.25	0.60	2780	1.53
1	Auxiliary crane (stand)		2.53	0.30	2.96	220 (80)	2.25
1	Platform 1 on counterjib 8033		2.73	0.66	0.33	100	0.59
2	Platform 2/3 on counterjib		1.72	0.66	0.33	75	0.37
1	Platform 4 on counterjib 8033		2.89	0.66	0.33	105	0.63
1	Platform 5 on counterjib 8033		2.77	0.66	0.33	100	0.60
1	Platform 6 on counterjib 8033		2.61	0.66	0.33	95	0.57
	Standard railings		2.60	1.10	0.65	300	1.86
1	Box (small parts)		0.63	0.50	0.38	100	1.12

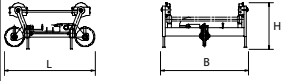
NOTICE! Bracketed weights must be added to their associated components.

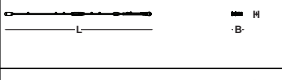
6.2 Package list 8033.16

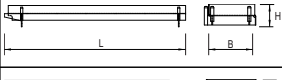
Quantity	Description	Package	L [m]	W [m]	H [m]	Weight [kg]	Volume [m³]		
1	Tower head section, complete with slewing frame, ball race bearing, slewing gear and slip ring system (stay parts on counterjib)		with UV 20 lower part of tower head section					15000 (410)	66.41
			with HT 23 lower part of tower head section					16300 (410)	76.34
			11.55	2.30	2.50				
1	Tower head section upper part (stay parts for counterjib)		with UV 20 lower part of tower head section					2925 (410)	30.55
			with HT 23 lower part of tower head section					12075	32.20
			5.60	2.30	2.50				
1	Tower head section lower part with slewing frame, ball race bearing, slewing gear and slip ring system		with UV 20 lower part of tower head section					13370	37.68
			with HT 23 lower part of tower head section					12075	32.20
			5.80	2.32	2.80				
1	Driver's cab with driver's cab suspension and control cabinet		4.82	2.19	2.55	3030	26.92		
1	Counterjib in hinged position (stay parts on counterjib)		11.98	2.30	1.31	7140 (865)	36.10		
	Counterjib (stay parts on counterjib)		22.24	2.30	0.72	7140 (865)	36.83		
1	Hoist winch platform Hw875FU (2. Brake) (210 m hoist rope) (290m hoist rope)		2.17	1.88	1.18	2250 (270) (370)	4.82		
1	Jib element 1 with traverse gear		10.19	1.64	2.29	3400	38.54		
1	Jib element 2		10.19	1.64	2.08	2460	34.76		
1	Jib element 3		10.23	1.64	2.08	2320	34.90		
1	Jib element 4		10.30	1.64	2.07	2300	34.97		

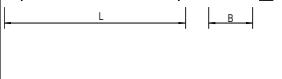
6 Package list

Quantity	Description	Package	L [m]	W [m]	H [m]	Weight [kg]	Volume [m ³]
1	Jib element 5		5.33	1.64	2.03	1135	17.74
1	Jib element 6		2.83	1.64	2.03	695	9.42
1	Jib element 7		10.28	1.64	2.03	1815	34.22
1	Jib element 8		10.22	1.64	2.02	1290	33.86
1	Jib element 9		5.20	1.64	2.01	660	17.14
1	Jib element 10		10.19	1.64	2.01	1040	33.59
1	Rope swivel cross-beam		1.38	1.54	0.50	245	1.06
1	Trolley LK 8/16		1.87	1.85	1.00	455	3.46
1	Maintenance cage		0.75	0.55	1.69	55	0.70
1	Hook block U 8/16		1.02	0.26	1.70	780	0.45
1	Brace rods for 80 m operating radius		10.17	0.25	0.60	2780	1.53
1	Auxiliary crane (stand)		2.53	0.30	2.96	220 (80)	2.25
1	Platform 1 on counterjib 8033		2.73	0.66	0.33	100	0.59
2	Platform 2/3 on counterjib		1.72	0.66	0.33	75	0.37
1	Platform 4 on counterjib 8033		2.89	0.66	0.33	105	0.63
1	Platform 5 on counterjib 8033		2.77	0.66	0.33	100	0.60
1	Platform 6 on counterjib 8033		2.61	0.66	0.33	95	0.57
	Standard railings		2.60	1.10	0.65	300	1.86
1	Box (small parts)		0.63	0.50	0.38	100	1.12

NOTICE! Bracketed weights must be added to their associated components.

7 Assembly weights

7.1 Counterweight blocks



NOTICE

The described diagrams of the concrete counterweights and central ballast blocks only show sketches. Have them issue the reinforcement charts by experts.

7 Assembly weights

7.1.1 Counterweight block, 2.7 t

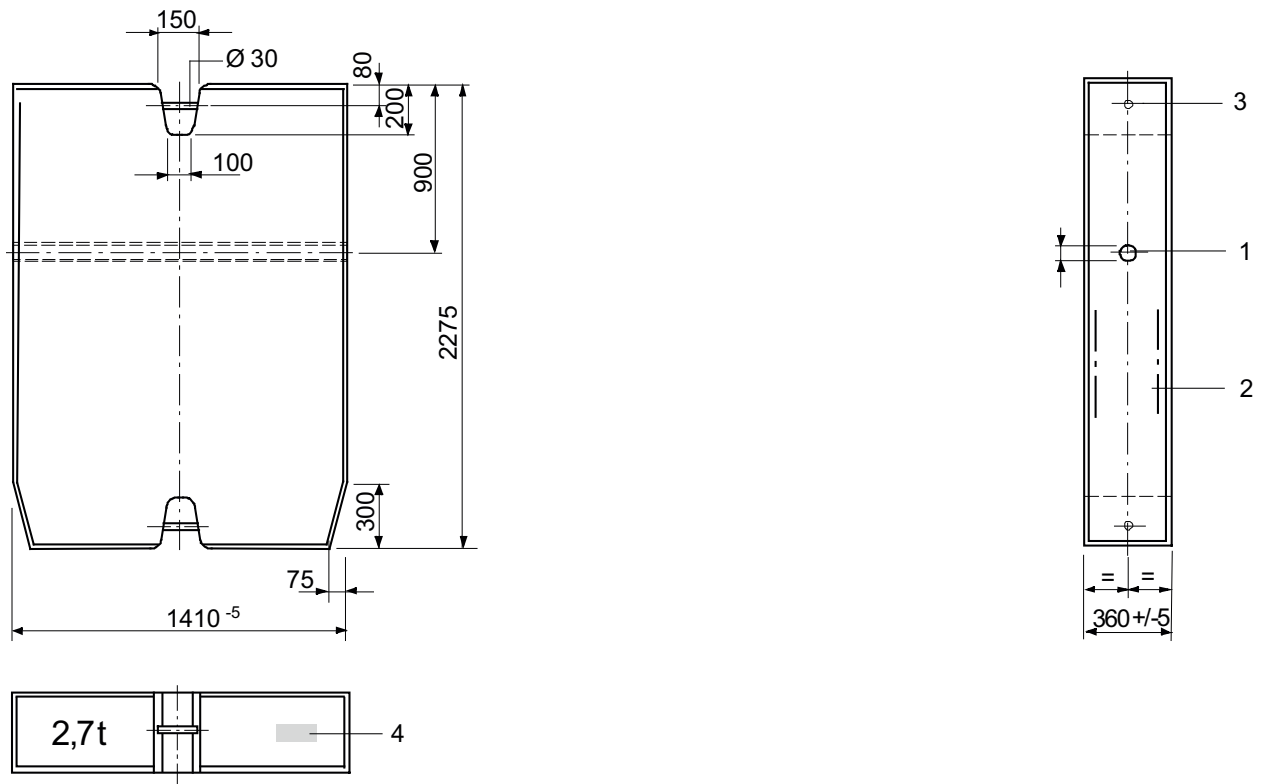

Data counterweight block 2.7 t

Item	Data
Material	Concrete, min. C 20/25
Max. permitted weight tolerance	+/- 3 %
Order number	30021887
1	Connection for stub shaft (Ø 40x 215 Item no.: 30024871)
2	Structural steel reinforcement
3	Suspension
4	Component identifier

7.1.2 Counterweight block, 3.0 t

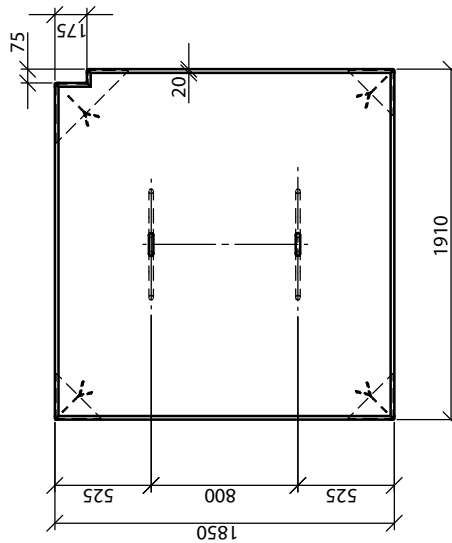
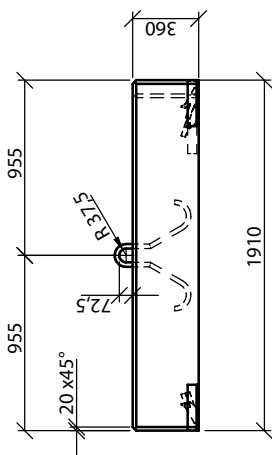
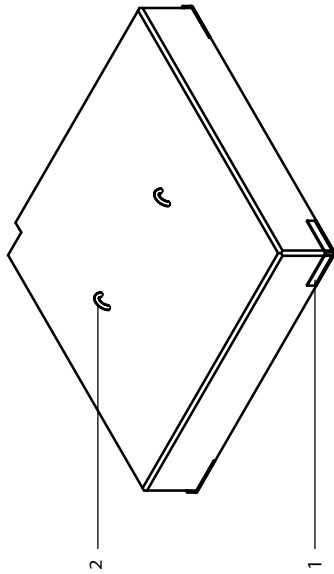

Data counterweight block 3.0 t

Item	Data
Material	Concrete, min. C 20/25
Max. permitted weight tolerance	+/- 3 %
Order number	30050551
1	Corner guard
2	Lifting eyes

7 Assembly weights

7.2 Total weight jib assembly

Assembly weights 8033.8

Trolley jib, complete: Trolley, trolley ropes, hook block, standard railings and rope swivel crossbeam

Jib length [m]	Weight [kg] WOLFF 8033.8cross
80.0	20215
77.5	20250
75.0	19555
72.5	19115
70.0	18420
67.5	19210
65.0	18515
62.5	18075
60.0	17380
57.5	17920
55.0	15575
52.5	15135
50.0	14440
47.5	14980
45.0	14285
42.5	13845
40.0	13150
37.5	13165
35.0	12470
32.5	12030
30.0	11335

Assembly weights 8033.16

Trolley jib, complete: Trolley, trolley ropes, hook block, standard railings and rope swivel crossbeam

Jib length [m]	Weight [kg] WOLFF 8033.16cross
80.0	20615
77.5	20650
75.0	19955
72.5	19515
70.0	18820
67.5	19610
65.0	18915
62.5	18475
60.0	17780
57.5	18320
55.0	15975
52.5	15535
50.0	14840
47.5	15380
45.0	14685
42.5	14245
40.0	13550
37.5	13565
35.0	12870
32.5	12430
30.0	11735

7 Assembly weights

7.3 Assembly weight slewing section

Assembly weights 8033.8 cross

Module	Crane parts	Weight [kg]
Tower head section, complete – tower connection TV 20 tower top lower part		15410
	▪ Tower head section upper part including brace plates	3335
	▪ Tower head section lower part including slewing frame, ball race bearing, slewing gears, standard railings and slip ring system	12075
Tower head section, complete – tower connection HT 23 tower top lower part		16710
	▪ Tower head section upper part including brace plates	3335
	▪ Tower head section lower part including slewing frame, ball race bearing, slewing gears, standard railings and slip ring system	13375
Operator cabinet platform, complete		2625
	▪ Operator cabin with operator cabin platform	2625
Operator cabinet platform, complete		3030
	▪ Driver's cab	940
	▪ Operator cabinet platform	1110
	▪ Control cabinet, resistor and small parts	980
Counter jib with Hw875FU, complete		14730
	▪ Counterjib with brace plates and standard railings	8910
	▪ Hoist winch platform Hw875FU (incl. 210 m hoisting cable)	2520
	▪ concrete weight 3.0 t (under hoisting winch platform)	3000
	▪ Auxiliary crane incl. stand	300

Assembly weights 8033.16 cross

Module	Crane parts	Weight [kg]
Tower head section, complete – tower connection TV 20 tower top lower part		15410
	▪ Tower head section upper part including brace plates	3335
	▪ Tower head section lower part including slewing frame, ball race bearing, slewing gears, standard railings and slip ring system	12075
Tower head section, complete – tower connection HT 23 tower top lower part		16710
	▪ Tower head section upper part including brace plates	3335
	▪ Tower head section lower part including slewing frame, ball race bearing, slewing gears, standard railings and slip ring system	13375
Operator cabinet platform, complete		2625
	▪ Operator cabin with operator cabin platform	2625
Operator cabinet platform, complete		3030

	▪ Driver's cab	940	
	▪ Operator cabinet platform	1110	
	▪ Control cabinet, resistor and small parts	980	
Counter jib with Hw875FU, complete			14830
	▪ Counterjib with brace plates and standard railings	8910	
	▪ Hoist winch platform Hw875FU (incl. 290 m hoisting rope)	2620	
	▪ concrete weight 3.0 t (under hoisting winch platform)	3000	
	▪ Auxiliary crane incl. stand	300	

7 Assembly weights

7.4 Assembly weight cross frame

Module	Crane part	Weight [kg]	
Cross frame KR 12 - 60 (without accessories)			14271
(6 m x 6 m)	▪ 4 bolted spigots AZ 140 M	788	
	▪ 4 bolted spigots AZ 140 E 10	788	
	▪ 4 bolted spigots AZ 156 M	844	
	▪ 4 bolted spigots AZ 140 E 17	875	
	▪ 4 bolted spigots AZ 160 HT23	668	
Cross frame KR 12 – 60/80 (without accessories)			17732
(8 m x 8 m)	▪ 4 bolted spigots AZ 140 M	788	
	▪ 4 bolted spigots AZ 140 E 10	788	
	▪ 4 bolted spigots AZ 156 M	844	
	▪ 4 bolted spigots AZ 140 E 17	875	
	▪ 4 bolted spigots AZ 160 HT23	668	
Cross frame KR 16 - 80 (without accessories)			21450
(8 m x 8 m)	▪ 4 bolted spigots AZ 140 E KR 16 – 80	620	
	▪ 4 bolted spigots AZ 156 M KR 16 – 80	680	
	▪ 4 bolted spigots AZ 156S M KR 16 - 80	675	
Cross frame KR 16 - 80/ 100 (without accessories)			25400
(10 m x 10 m)	▪ 4 bolted spigots AZ 140 E KR 16 – 80	620	
	▪ 4 bolted spigots AZ 156 M KR 16 – 80	680	
	▪ 4 bolted spigots AZ 156S M KR 16 - 80	675	

7.5 Assembly weights traveling cross frame

Module	Crane part	Weight [kg]	
Traveling cross frame KRF4 12-60/80 complete			32300
(8.0 m x 8.0 m)	▪ Cross frame	14170	
	▪ Backing braces	2875	
	▪ Drive gear corners	4560	
	▪ Subframe	9380	
	▪ Platforms and ladders	255	
	▪ Control cabinet	130	
	▪ small items	930	
	▪ Set of bolted spigots AZR 140 M KR 12-60/80	790	
	▪ Set of bolted spigots AZ 120 E 15,5 KR 12-60/80	730	
	▪ Set of bolted spigots AZ 140 E 15,5 KR 12-60/80	875	
	▪ Set of bolted spigots AZR 160 M KR 12-60/80	905	
	▪ Set of bolted spigots AZ 140 E 10 KR 12-60/80	790	
	▪ Set of bolted spigots AZR 156 M KR 12-60/80	845	
Traveling cross frame KRF6 12-60/80 complete			41200
(8.0 m x 8.0 m)	▪ Cross frame	14170	
	▪ Backing braces	2875	
	▪ Drive gear corners	4560	
	▪ Subframe	18270	
	▪ Platforms and ladders	255	
	▪ Control cabinet	130	
	▪ small items	940	
	▪ Set of bolted spigots AZR 140 M KR 12-60/80	790	
	▪ Set of bolted spigots AZ 120 E 15,5 KR 12-60/80	730	
	▪ Set of bolted spigots AZ 140 E 15,5 KR 12-60/80	875	
	▪ Set of bolted spigots AZR 160 M KR 12-60/80	905	
	▪ Set of bolted spigots AZ 140 E 10 KR 12-60/80	790	
	▪ Set of bolted spigots AZR 156 M KR 12-60/80	845	

7 Assembly weights

7.6 Assembly weight cross frame elements

Module	Crane parts	Weight [kg]	
	Cross frame element KRE 260.2, complete		10 900
	▪ Cross frame platform with hinged section, corner plates and transport locks	5 455	
	▪ Mast base with diagonal struts and tie rods	5 445	
	Cross frame element KRE 480 complete		24 250
	▪ Mast base	7 100	
	▪ Hinged sections with corner plates	6 250	
	▪ Diagonal struts and ballast carrier	9 260	
	▪ Assembly platform, ladder, and small parts	1 640	

7.7 Assembly weight undercarriage

Module	Crane parts	Weight [kg]	
Undercarriage UW 260.3, complete			17 200
	▪ Undercarriage platform with hinged sections, subframes and transport locks	11 300	
	▪ Mast base with diagonal struts and tie rods	5 900	
Undercarriage UW 480, complete			34 000
	▪ Mast base	7 100	
	▪ Hinged sections with mounting device and subframes	16 000	
	▪ Diagonal struts and ballast carrier	9 260	
	▪ Assembly platform, ladder, and small parts	1 640	

7 Assembly weights

7.8 Required hook height for mobile cranes

For information about the height of the WOLFF slewing tower crane, refer to Tower combinations [16].

NOTICE! During assembly, allowances must be made for level differences (mobile crane to base of the slewing tower crane).

Hook height above ground required for mobile cranes (X) = height of the WOLFF slewing tower crane (A) + clearance of 15 m (B).

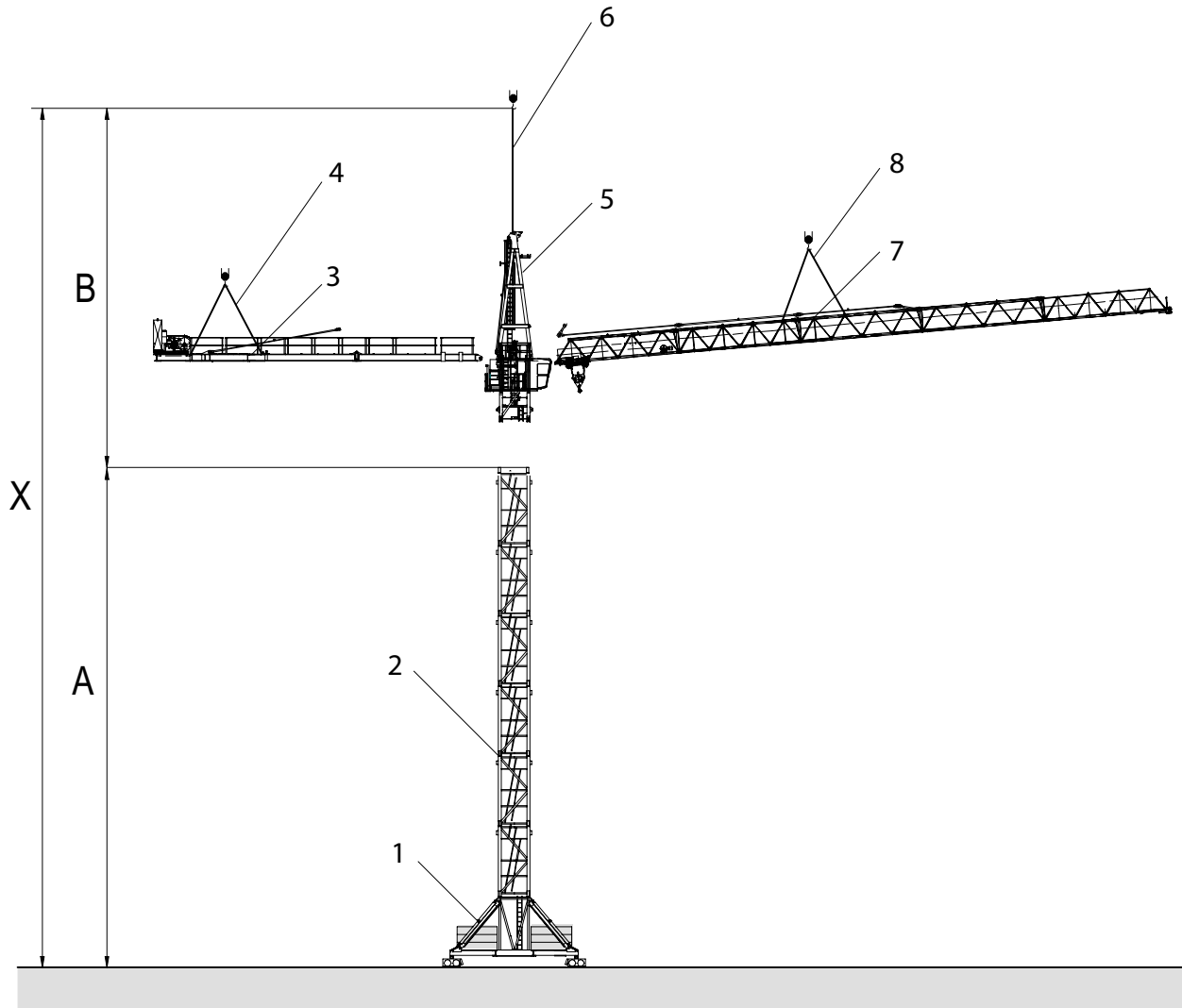

Exemplary illustration

[A]	Height of the WOLFF slewing tower crane	[B]	Clearance 15 m
[X]	Hook height above ground required for the mobile crane		
1	Substructure	5	Tower head section, complete
2	Tower element	6	Single-point lifting tackle (1 m with shackle)
3	Counterjib including hoisting winch platform	7	Jib, complete
4	Four-point lifting tackle (6 m with shackle)	8	Four-point lifting tackle (6 m with shackle)

(see also):

- Tower combinations [\[16\]](#)

8 Assembly diagrams

8 Assembly diagrams

8.1 Jib attachment diagram

	NOTICE
	For jib assembly, use a Four-point lifting tackle (6 m with shackle).

Length of jib elements

Item	Length [m]
Jib element 1, 2, 3, 4, 7, 8, 10	10
Jib element 5, 9	5
Jib element 6	2.5

8.1.1 Trolley jib - attachment diagram 8033.8

8.1.1.1 Trolley jib - attachment diagram 80.0 m to 75.0 m

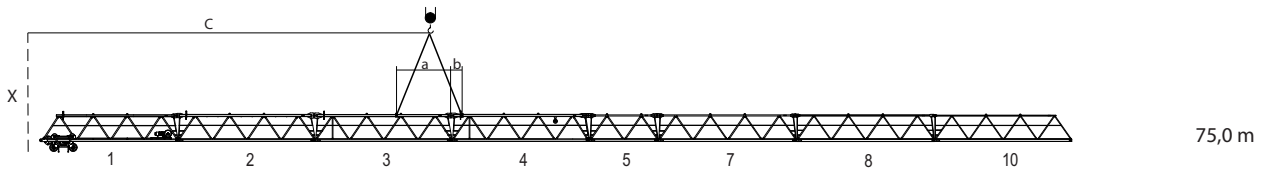
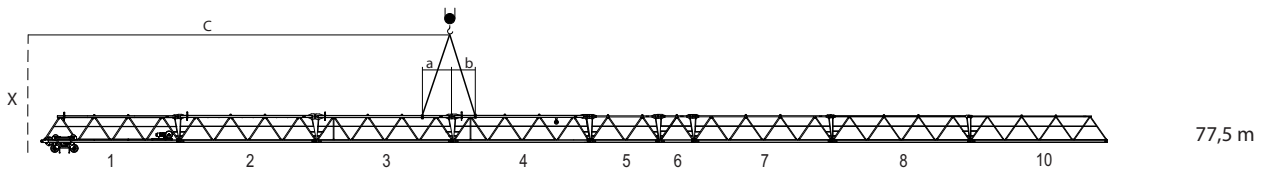
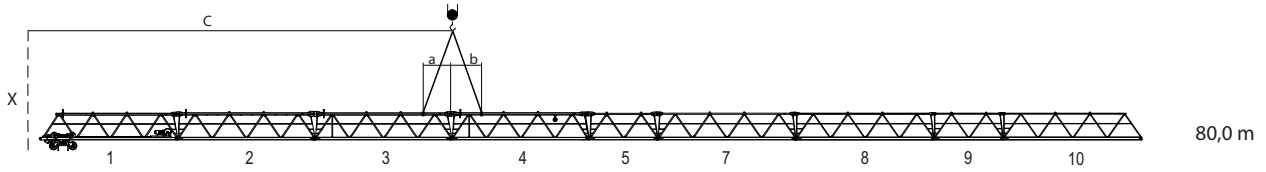

a	Dimension a	b	Dimension b
c	Dimension c	X	Middle of tower

Attachment data 8033.8

Data	Jib length [m]		
	80.0	77.5	75.0
a [m]	2.14	2.14	3.91
b [m]	2.35	1.61	0.67
c [m]	31.30	30.90	29.50
Weight [kg]	20215	20250	19555

8 Assembly diagrams

8.1.1.2 Trolley jib - attachment diagram 72.5 m to 67.5 m

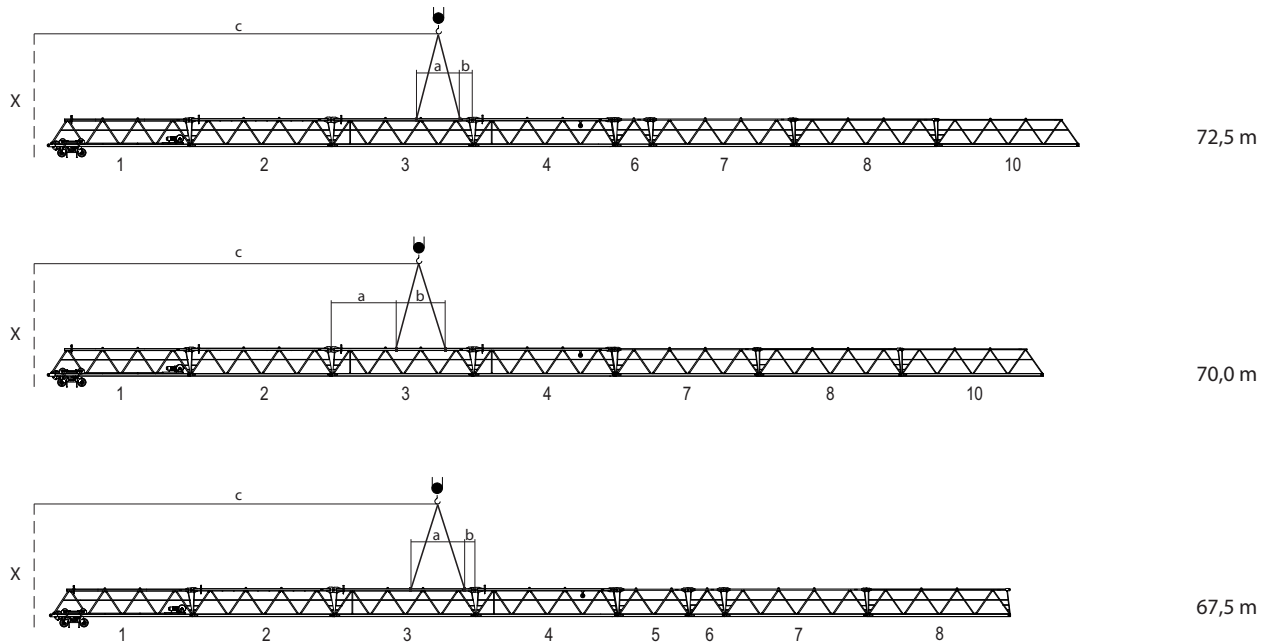

a	Dimension a	b	Dimension b
c	Dimension c	X	Middle of tower

Attachment data 8033.8

Data	Jib length [m]		
	72.5	70.0	67.5
a [m]	3.02	4.56	3.76
b [m]	0.89	3.59	0.89
c [m]	28.80	27.50	28.40
Weight [kg]	19115	18420	19210

8.1.1.3 Trolley jib - attachment diagram 65.0 m to 60.0 m

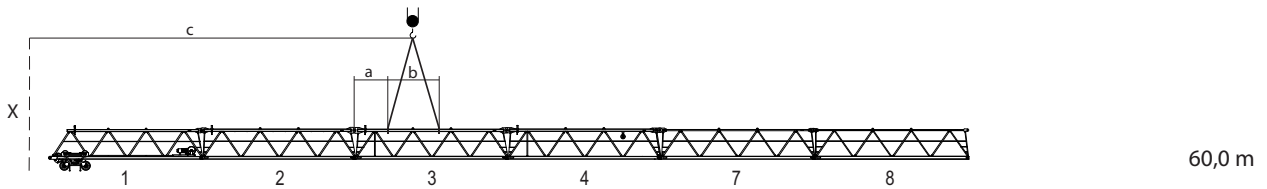
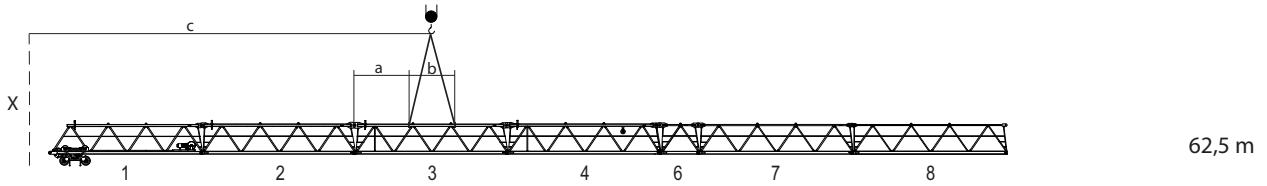
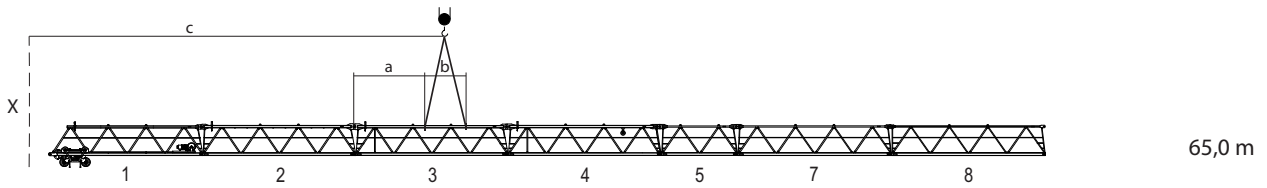

a	Dimension a	b	Dimension b
c	Dimension c	X	Middle of tower

Attachment data 8033.8

Data	Jib length [m]		
	65.0	62.5	60.0
a [m]	4.56	3.59	2.06
b [m]	2.79	3.02	3.59
c [m]	27.10	26.30	25.00
Weight [kg]	18515	18075	17380

8 Assembly diagrams

8.1.1.4 Trolley jib - attachment diagram 57.5 m to 52.5 m

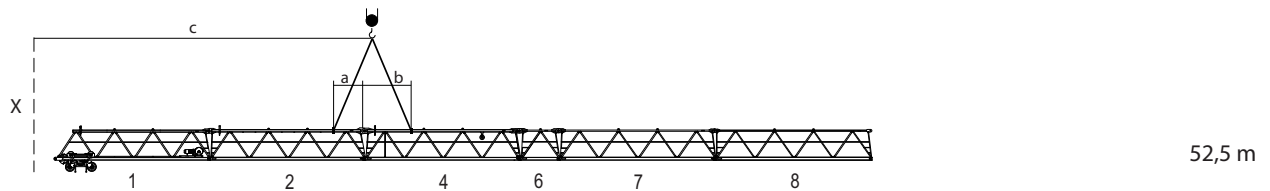
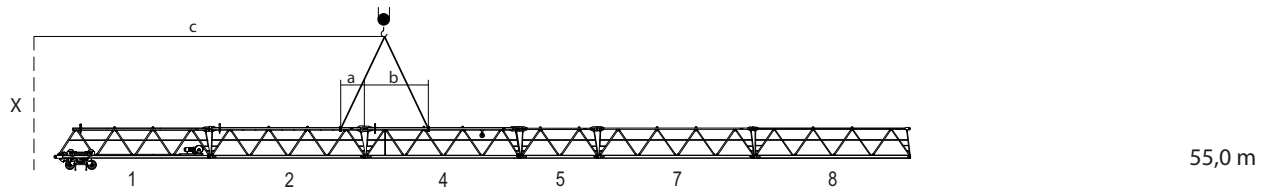
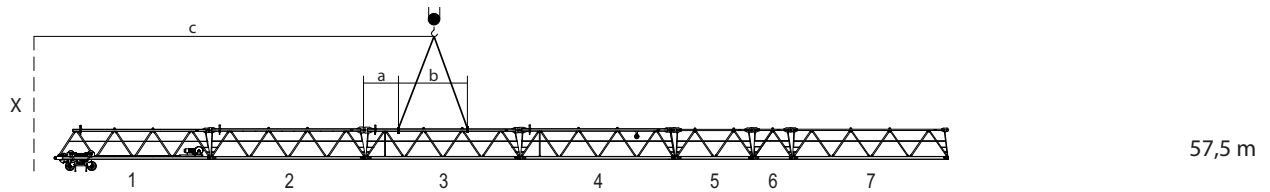

a	Dimension a	b	Dimension b
c	Dimension c	X	Middle of tower

Attachment data 8033.8

Data	Jib length [m]		
	57.5	55.0	52.5
a [m]	2.06	1.42	2.14
b [m]	4.56	4.11	3.15
c [m]	25.50	22.50	21.70
Weight [kg]	17920	15575	15135

8.1.1.5 Trolley jib - attachment diagram 50.0 m to 45.0 m

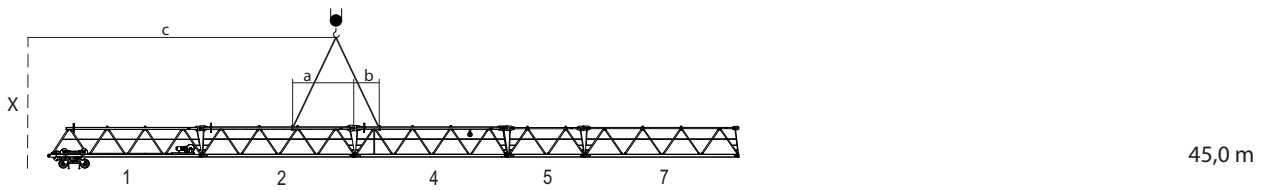
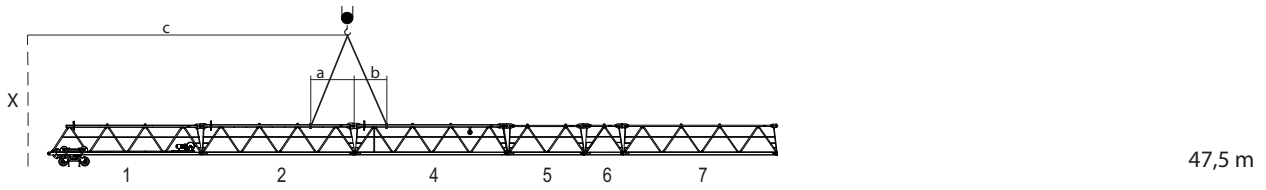
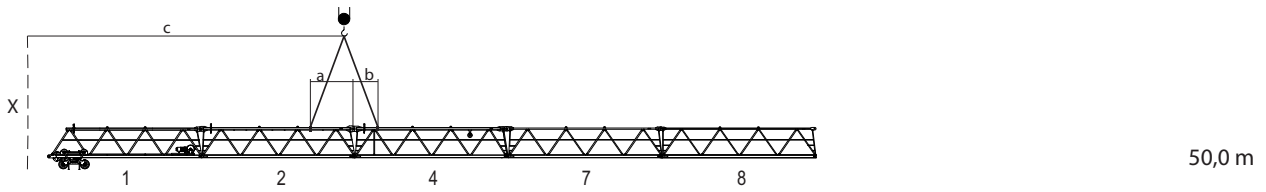

a	Dimension a	b	Dimension b
c	Dimension c	X	Middle of tower

Attachment data 8033.8

Data	Jib length [m]		
	50.0	47.5	45.0
a [m]	2.94	2.94	3.92
b [m]	1.61	2.35	1.61
c [m]	20.50	20.90	20.00
Weight [kg]	14440	14980	14285

8 Assembly diagrams

8.1.1.6 Trolley jib - attachment diagram 42.5 m to 37.5 m

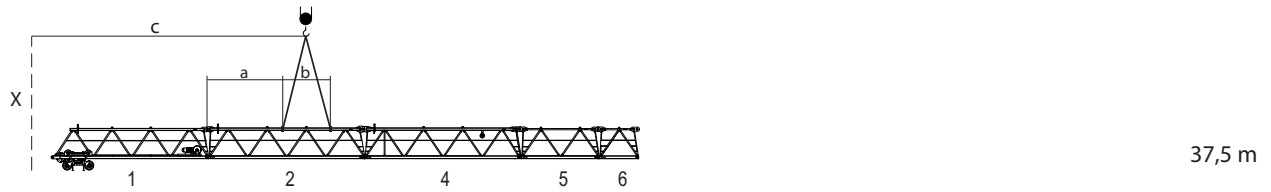
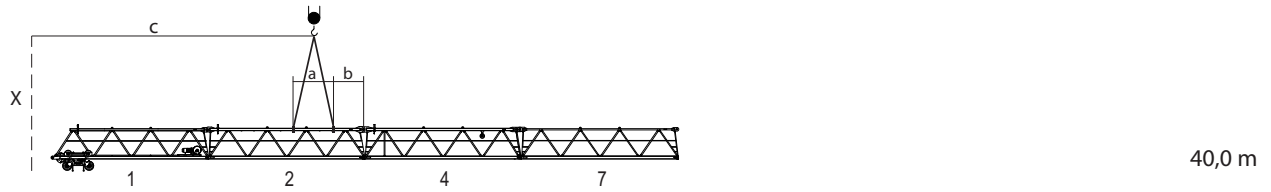
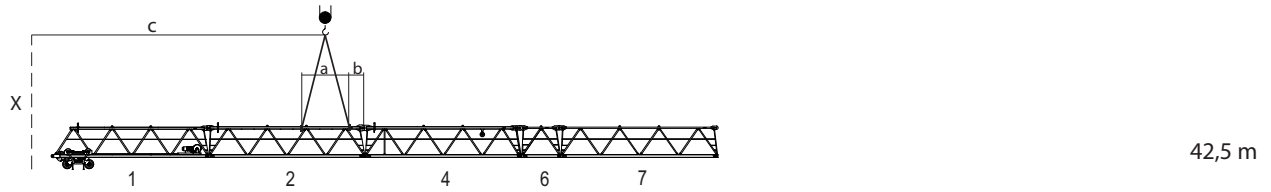

a	Dimension a	b	Dimension b
c	Dimension c	X	Middle of tower

Attachment data 8033.8

Data	Jib length [m]		
	42.5	40.0	37.5
a [m]	3.03	2.79	4.56
b [m]	0.89	1.85	3.59
c [m]	18.80	17.90	17.50
Weight [kg]	13845	13150	13165

8.1.1.7 Trolley jib - attachment diagram 35.0 m to 30.0 m

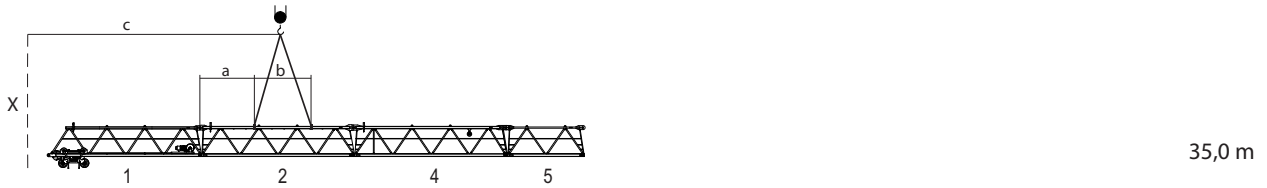

a	Dimension a	b	Dimension b
c	Dimension c	X	Middle of tower

Attachment data 8033.8

Data	Jib length [m]		
	35.0	32.5	30.0
a [m]	3.58	2.06	2.06
b [m]	3.77	5.29	2.79
c [m]	16.60	15.90	14.60
Weight [kg]	12470	12030	11335

8 Assembly diagrams

8.1.2 Trolley jib - attachment diagram 8033.16

8.1.2.1 Trolley jib - attachment diagram 80.0 m to 75.0 m

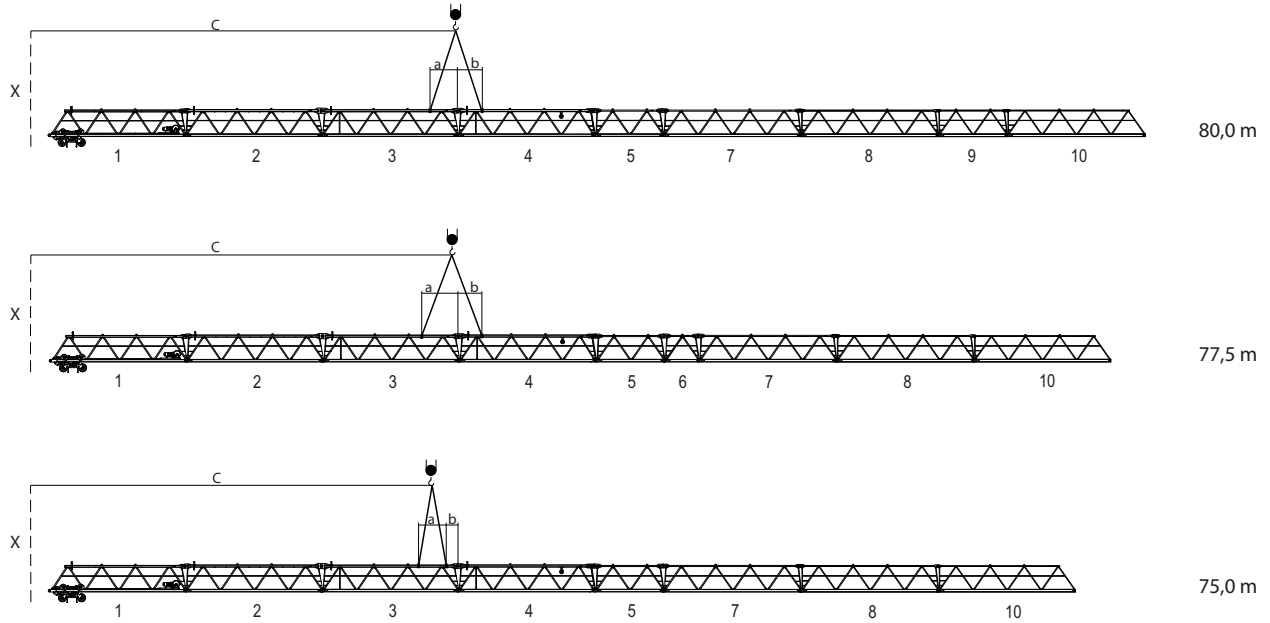

a	Dimension a	b	Dimension b
c	Dimension c	X	Middle of tower

Attachment data 8033.16

Data	Jib length [m]		
	80.0	77.5	75.0
a [m]	2.14	2.94	2.06
b [m]	1.61	1.61	0.89
c [m]	30.90	30.50	29.20
Weight [kg]	20615	20650	19955

8.1.2.2 Trolley jib - attachment diagram 72.5 m to 67.5 m

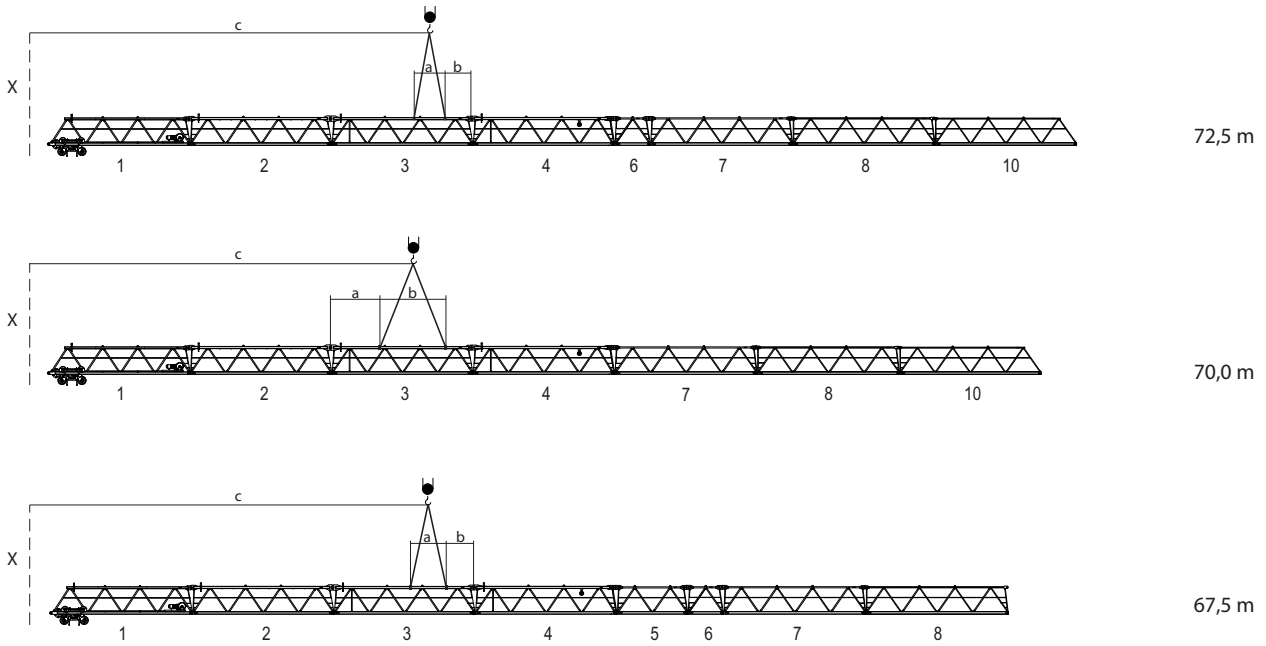

a	Dimension a	b	Dimension b
c	Dimension c	X	Middle of tower

Attachment data 8033.16

Data	Jib length [m]		
	72.5	70.0	67.5
a [m]	2.06	3.59	2.79
b [m]	1.85	4.56	1.85
c [m]	28.30	27.00	27.90
Weight [kg]	19515	18820	19610

8 Assembly diagrams

8.1.2.3 Trolley jib - attachment diagram 65.0 m to 60.0 m

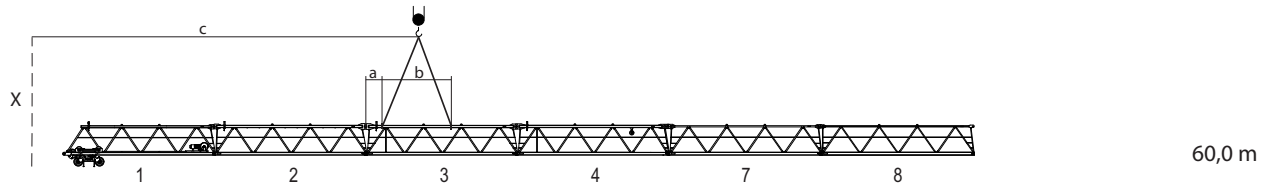
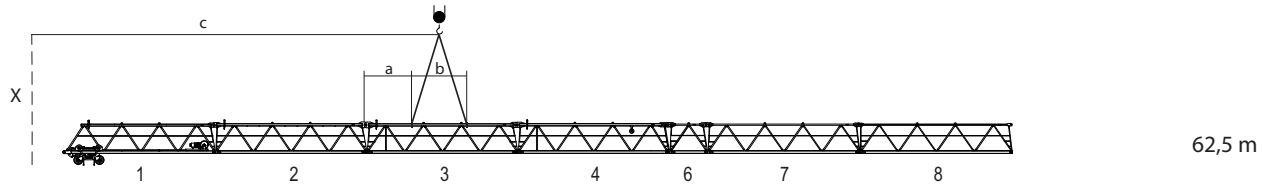
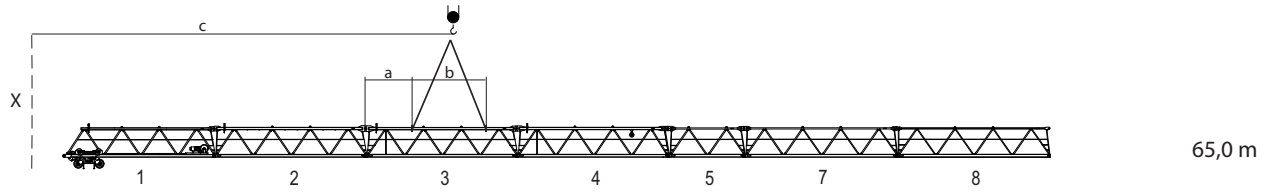

a	Dimension a	b	Dimension b
c	Dimension c	X	Middle of tower

Attachment data 8033.16

Data	Jib length [m]		
	65.0	62.5	60.0
a [m]	2.86	2.86	1.09
b [m]	5.29	3.76	4.56
c [m]	26.70	25.90	24.50
Weight [kg]	18915	18475	17780

8.1.2.4 Trolley jib - attachment diagram 57.5 m to 52.5 m

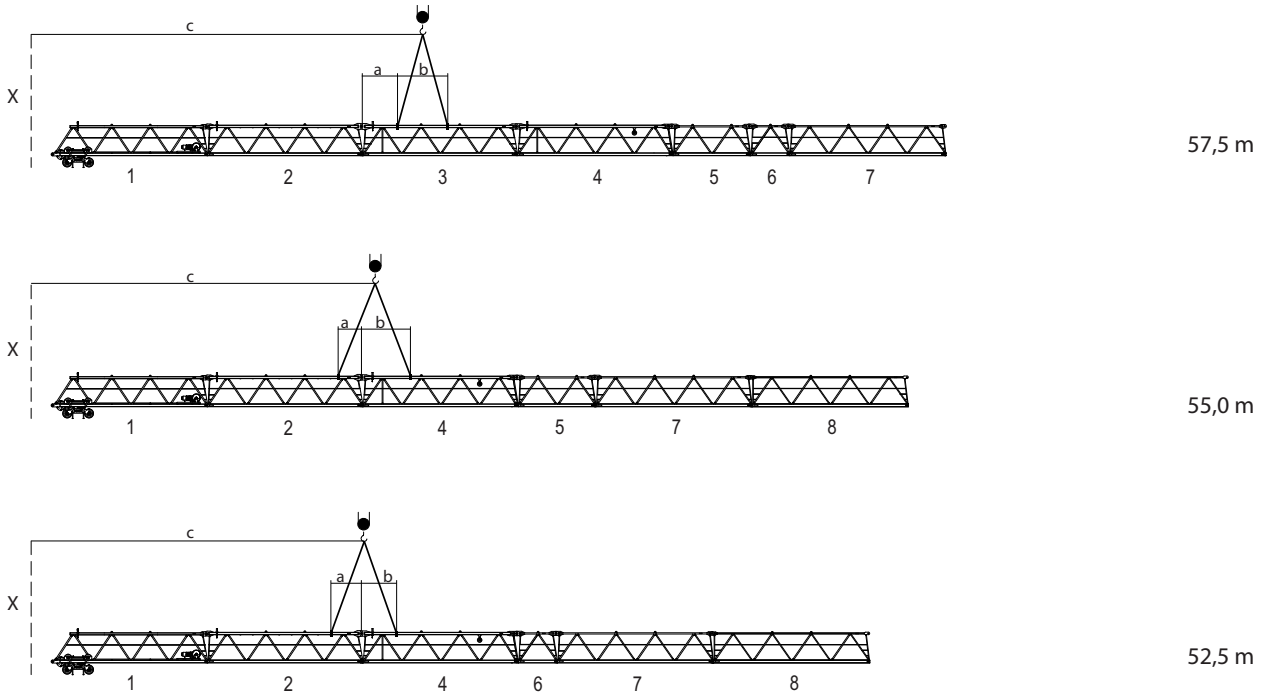

a	Dimension a	b	Dimension b
c	Dimension c	X	Middle of tower

Attachment data 8033.16

Data	Jib length [m]		
	57.5	55.0	52.5
a [m]	2.06	1.42	2.14
b [m]	3.59	3.15	2.35
c [m]	25.00	22.00	21.30
Weight [kg]	18320	15975	15535

8 Assembly diagrams

8.1.2.5 Trolley jib - attachment diagram 50.0 m to 45.0 m

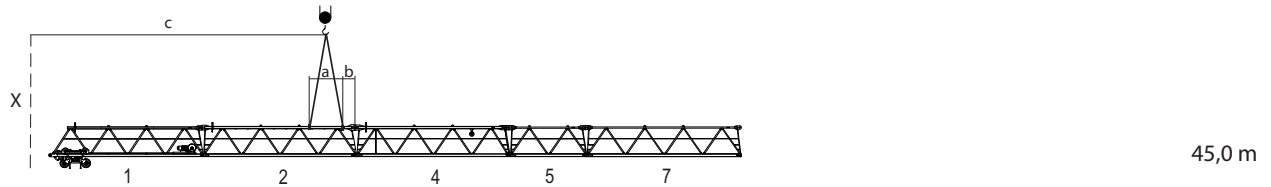
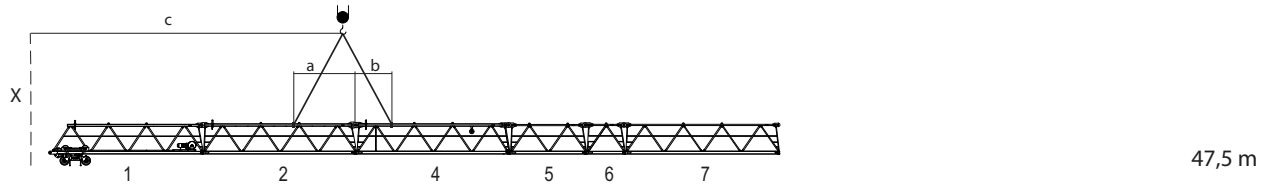
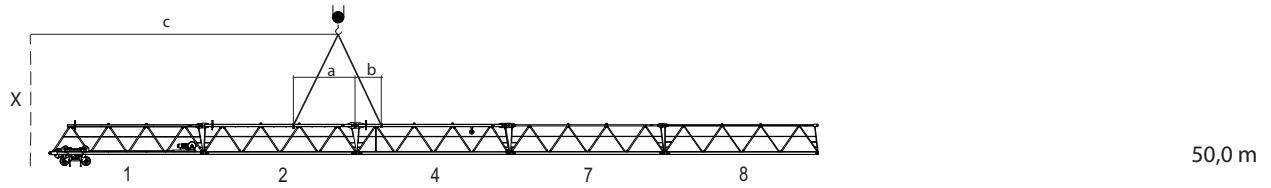

a	Dimension a	b	Dimension b
c	Dimension c	X	Middle of tower

Attachment data 8033.16

Data	Jib length [m]		
	50.0	47.5	45.0
a [m]	3.92	3.92	2.06
b [m]	1.61	2.35	0.89
c [m]	20.00	20.40	19.20
Weight [kg]	14840	15380	14685

8.1.2.6 Trolley jib - attachment diagram 42.5 m to 37.5 m

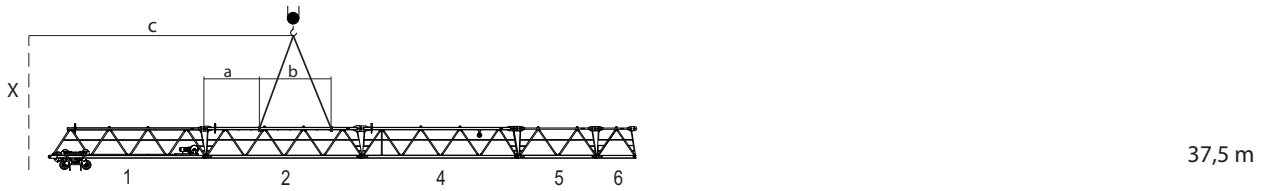
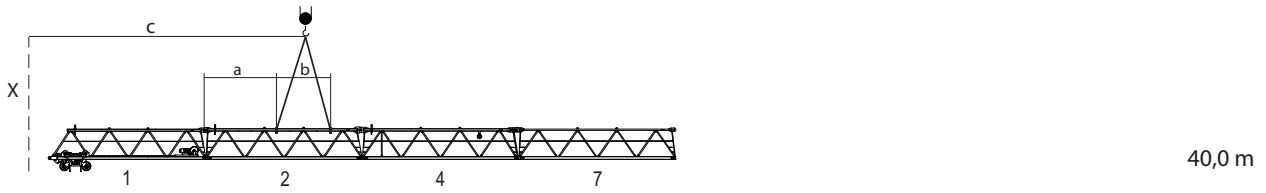
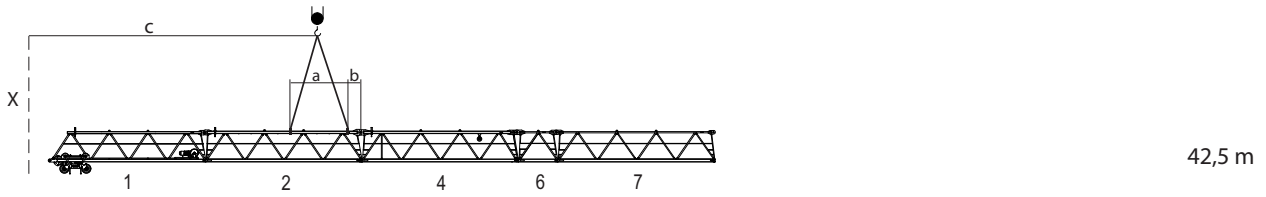

a	Dimension a	b	Dimension b
c	Dimension c	X	Middle of tower

Attachment data 8033.16

Data	Jib length [m]		
	42.5	40.0	37.5
a [m]	3.76	4.56	3.58
b [m]	0.89	3.59	4.57
c [m]	18.40	17.50	17.00
Weight [kg]	14245	13550	13565

8 Assembly diagrams

8.1.2.7 Trolley jib - attachment diagram 35.0 m to 30.0 m

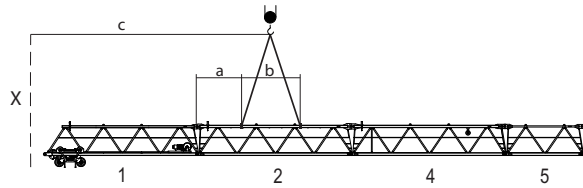

35,0 m

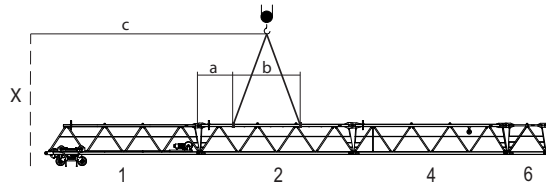

32,5 m

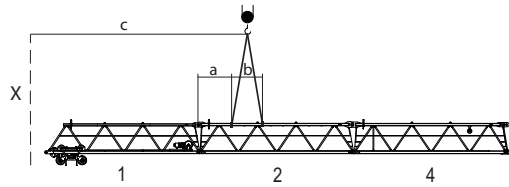

30,0 m

a	Dimension a	b	Dimension b
c	Dimension c	X	Middle of tower

Attachment data 8033.16

Data	Jib length [m]		
	35.0	32.5	30.0
a [m]	2.86	2.06	2.06
b [m]	3.76	4.56	2.06
c [m]	15.90	15.50	14.20
Weight [kg]	12870	12430	11735

8.2 Jib brace diagram

Brace diagram 80.0 m – 57.5 m

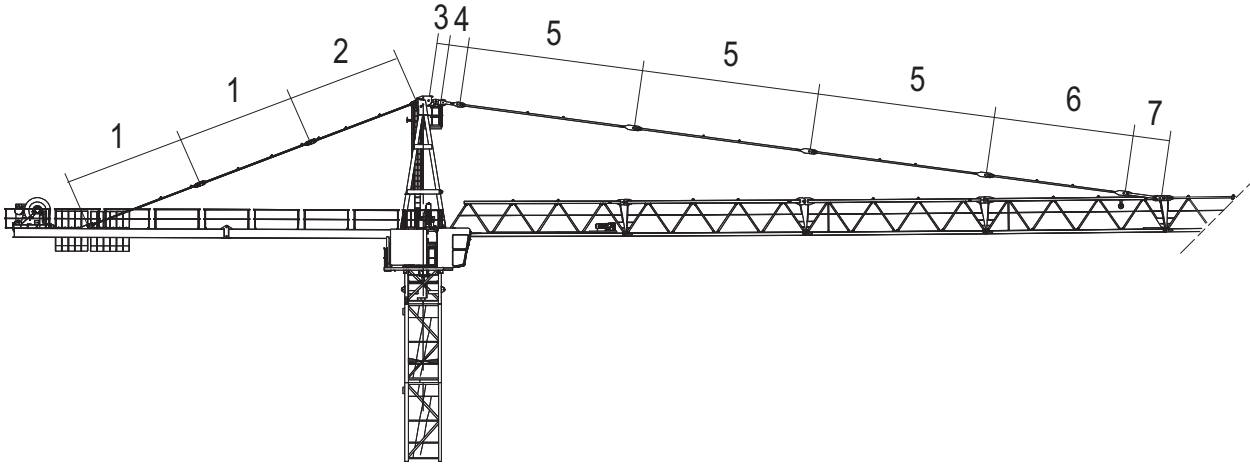

Brace table

Brace	Lengths [mm]							Brace types
	Brace no. 1	Brace no. 2	Brace no. 3	Brace no. 4	Brace no. 5	Brace no. 6	Brace no. 7	
Counterjib	6579	6225	-	-	-	-	-	double
Jib	-	-	400	1210	9856	7752	2020	single

Bolt table brace 80.0 m – 57.5 m

Item	Brace	Fastening			Fuse		
		Quantity	Designation	Dimensions	Quantity	Component	Dimensions
Counterjib brace	1	4	Bolts	Ø 70/60x152	4	Spring retainers	10/60-80
	2	2	Bolts	Ø 70/60x152	2	Spring retainers	10/60-80
Jib brace	3	1	Bolts	Ø 100/90x235	1	Cotter pin	13x125
	4	2	Bolts	Ø 100/90x225	2	Cotter pin	13x125
					2	Washer	130/91x4
	5	3	Bolts	Ø 100/90x225	3	Cotter pin	13x125
	6	1	Bolts	Ø 100/90x225	1	Cotter pin	13x125
	7	1	Collar bolt	Ø 110/90x325	1	Axle retainer	40x10x140
					2	Circlip	A16
				2	Hexagonal head screw	M16x40-8.8	

8 Assembly diagrams

Brace diagram 55.0 m – 30.0 m

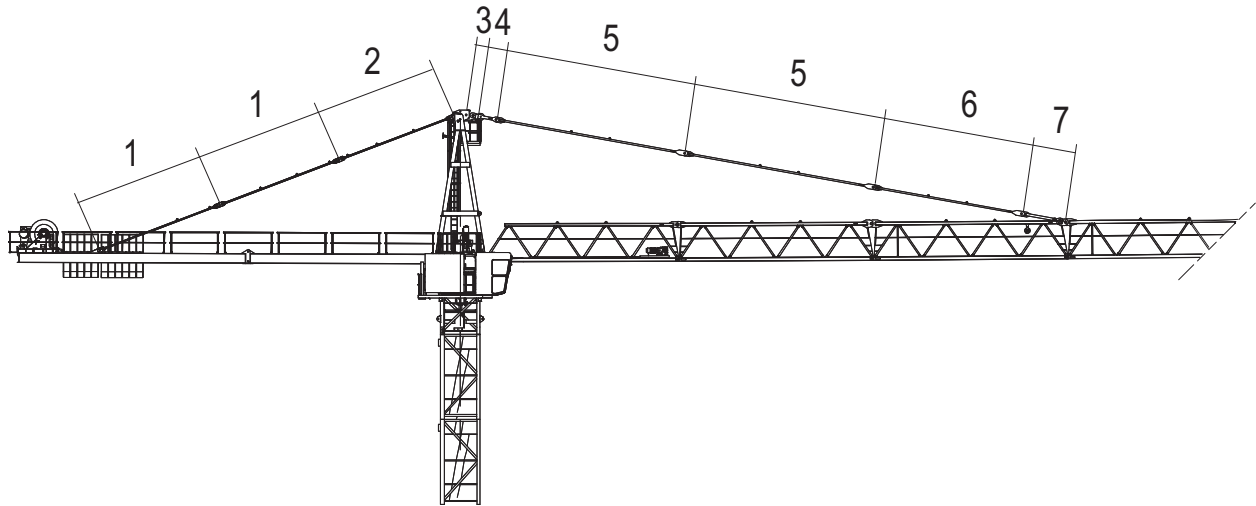

Brace table

Brace	Lengths [mm]							Brace types
	Brace no. 1	Brace no. 2	Brace no. 3	Brace no. 4	Brace no. 5	Brace no. 6	Brace no. 7	
Counterjib	6579	6225	-	-	-	-	-	double
Jib	-	-	400	1210	9856	7752	2020	single

Bolt table brace 80.0 m – 57.5 m

Item	Brace	Fastening			Fuse		
		Quantity	Designation	Dimensions	Quantity	Component	Dimensions
Counterjib brace	1	4	Bolts	Ø 70/60x152	4	Spring retainers	10/60-80
	2	2	Bolts	Ø 70/60x152	2	Spring retainers	10/60-80
Jib brace	3	1	Bolts	Ø 100/90x235	1	Cotter pin	13x125
	4	2	Bolts	Ø 100/90x225	2	Cotter pin	13x125
					2	Washer	130/91x4
	5	2	Bolts	Ø 100/90x225	2	Cotter pin	13x125
	6	1	Bolts	Ø 100/90x225	1	Cotter pin	13x125
	7	1	Collar bolt	Ø 110/90x325	1	Axle retainer	40x10x140
					2	Circlip	A16
				2	Hexagonal head screw	M16x40-8.8	

8.3 Trolley jib mounting rig

	NOTICE
	<p>For information on the arrangement of the mounting rig, refer to the attachment diagram.</p> <p>Two mounting rigs are required per slewing tower crane.</p>

Elements required for each mounting rig

Quantity	Item	Type
1	Mounting rig	
4	Hexagonal head bolt	M16x220-8.8 ISO 4014
8	Hexagonal nut	M16-8 ISO 4032
8	Lock nut	M16 DIN 7967

Mounting rig

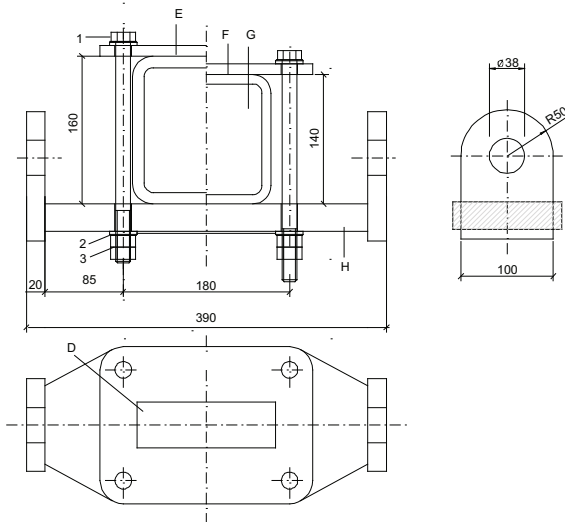

1	Hexagonal head screw	A	Mounting rig
2	HSFG washer	B	Top chord trolley jib
3	Hexagonal nut		

8 Assembly diagrams

8.4 Arrangement of standard railings

8.4.1 Standard railings (NG) and accessories

Quantity	Standard railings (NG) / accessories	Article no.
10	Standard railing NG 2500	30018798
12	Standard railing NG 2000	30018797
3	Standard railing NG 1500	30018796
2	Standard railing NG 1000	30018795
2	Standard railing NG 750	30018794
11	Standard railings NG 500	30018793
4	Standard posts Ø 42.4 mm x 1090 mm	30000167
1	RS (hoop guard)	30044244
1	Support block 645 mm (AB 1)	30050695
1	Support block 1140 mm (AB 2)	30050697

8.4.2 Arrangement of standard railings

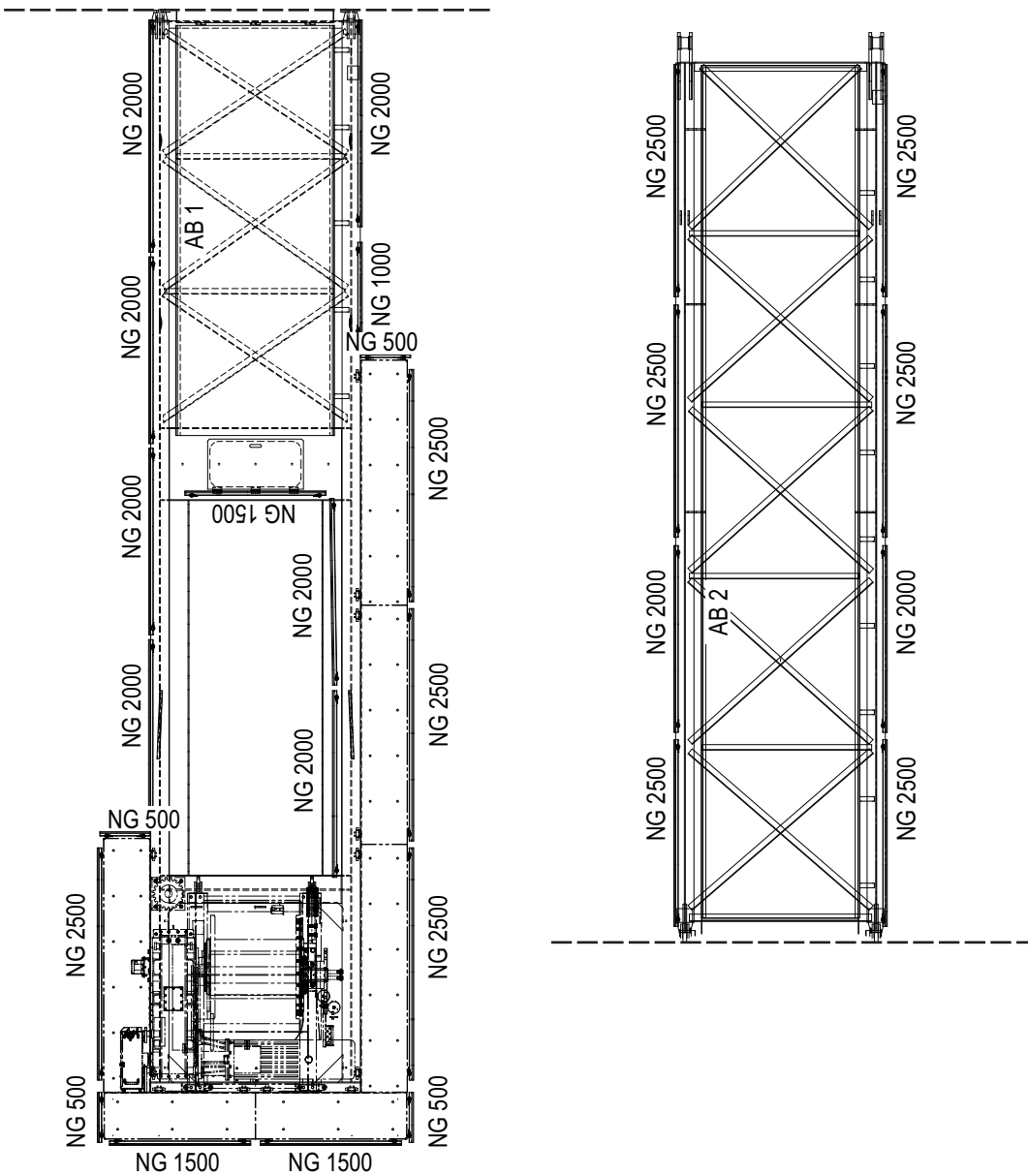

Arrangement of standard railings, counterjib

8 Assembly diagrams

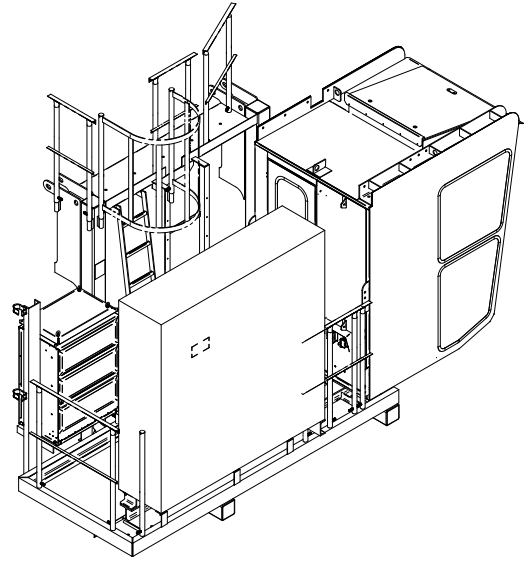
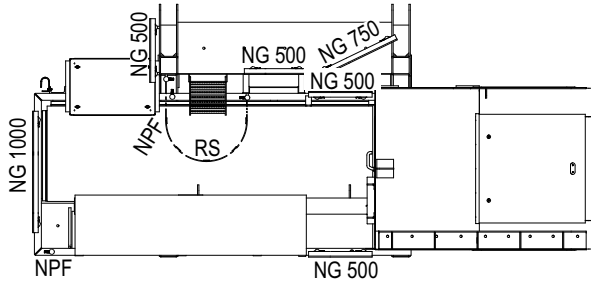

Arrangement of standard railings, driver's cab

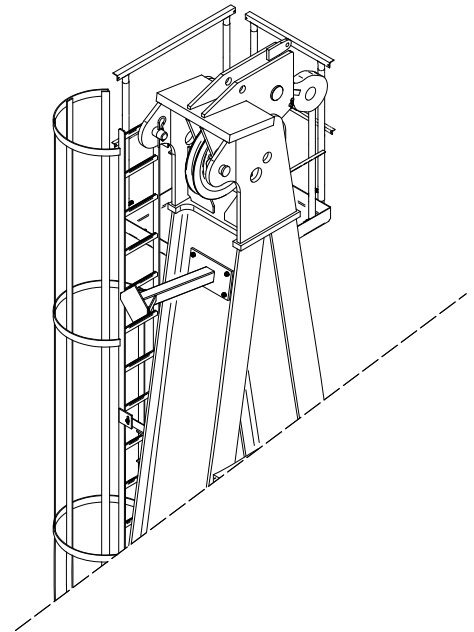
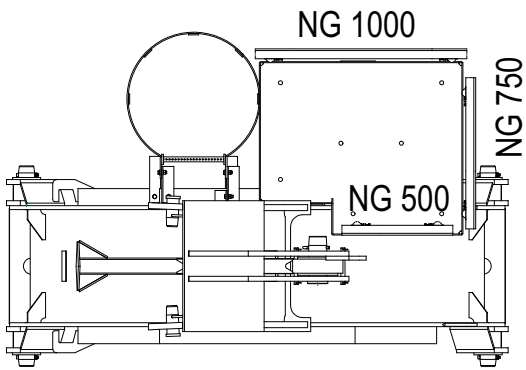

Arrangement of standard railings, tower head section

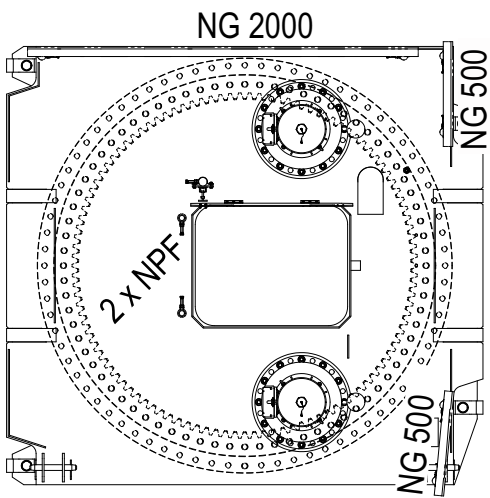

Arrangement of standard railings, slewing frame

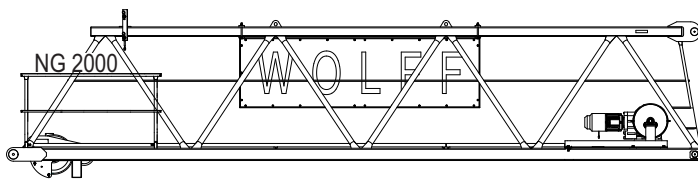
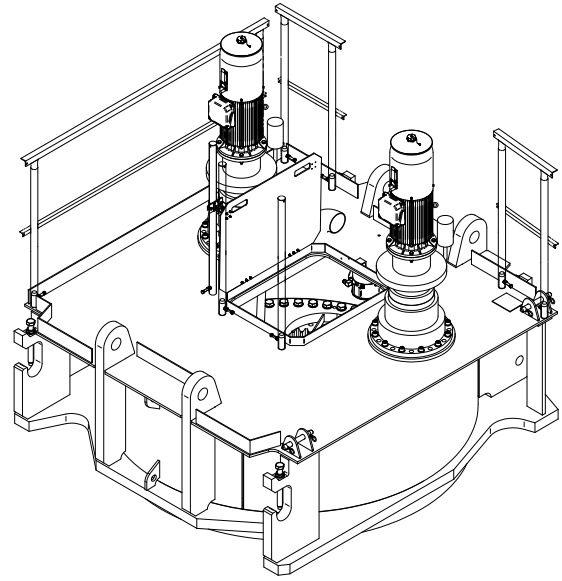

Arrangement of standard railings, jib element 1

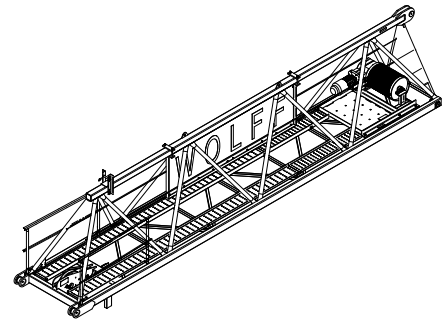





9 Suitable climbing devices



9 Suitable climbing devices

This section contains information on

- Outer climbing devices (KWH)
- Inner climbing devices (KSH)

	<p style="text-align: center;">NOTICE</p> <p>Details on the climbing device Always refer to the details in the documentation of the climbing device.</p>
	<p style="text-align: center;">NOTICE</p> <p>The operating radius specified is measured from the tower center and is to be considered a reference value. Exact balancing can be achieved by changing the operating radius with the tower elements or loads specified in the table.</p>
	<p style="text-align: center;">NOTICE</p> <p>Details for climbing balancing The climbing balancing details apply to the snatch block in maximum hook position.</p>
	<p style="text-align: center;">NOTICE</p> <p>If feasible, preferably operate your climbing device without balancing weight.</p>

9.1 Outer climbing devices

	<p style="text-align: center;">! DANGER</p> <p>Climbing device attached to the lower part of the tower head section lower part.</p> <p>Increased wind surface. The slewing tower crane may overturn.</p> <ul style="list-style-type: none">▶ Dismantle the climbing device after the climbing procedure is finished or lower the climbing device down on the ground or lower the climbing device down to the uppermost tower brace.
	<p style="text-align: center;">NOTICE</p> <p>Tower element on the transfer carriage</p> <p>The data on climbing balance was specified under the assumption that a tower element is on the transfer carriage.</p>

9 Suitable climbing devices

9.1.1 Outer climbing device KWH 20.6 / KWH 20.6.1 / KWH 20.6.2

Climbing radius 8033.8 cross

Climbing radius for the balancing weights

8033.8	Jib length						
	80	77.5	75	72.5	70	67.5	65
no weight	38.8	47.1	-	-	-	-	-
TV 20 = 2.98 t	8.4	10.4	21.8	29.9	28.6	30.9	29.8
Weight = 5.0 t	-	6.4	14.0	19.3	18.5	20.0	19.3
Weight = 10.0 t	-	-	-	-	-	-	-

Climbing radius for the balancing weights

8033.8	Jib length						
	62.5	60	57.5	55	52.5	50	47.5
no weight	-	-	-	-	-	-	-
TV 20 = 2.98 t	37.2	35.6	41.1	44.2	42.0	-	-
Weight = 5.0 t	24.2	23.1	26.7	28.8	27.3	29.8	28.8
Weight = 10.0 t	-	-	-	-	-	-	-

Climbing radius for the balancing weights

8033.8	Jib length						
	45	42.5	40	37.5	35	32.5	30
no weight	-	-	-	-	-	-	-
TV 20 = 2.98 t	-	-	-	-	-	-	-
Weight = 5.0 t	27.8	29.7	28.2	28.6	30.0	-	-
Weight = 10.0 t	-	-	-	-	-	17.3	16.8

Climbing radius 8033.16 cross

Climbing radius for the balancing weights

8033.16	Jib length [m]						
	80	77.5	75	72.5	70	67.5	65
no weight	26.9	32.7	-	-	-	-	-
TV 20 = 2.98 t	7.5	9.3	19.7	27.0	25.9	27.9	27.0
Weight = 5.0 t	-	6.0	13.0	18.0	17.2	18.6	18.0
Weight = 10.0 t	-	-	-	-	-	-	-

Climbing radius for the balancing weights

8033.16	Jib length [m]						
	62.5	60	57.5	55	52.5	50	47.5
no weight	-	-	-	-	-	-	-
TV 20 = 2.98 t	33.7	32.2	37.1	40.0	38.0	41.4	40.1
Weight = 5.0 t	22.6	21.5	24.9	26.9	25.5	27.8	26.9
Weight = 10.0 t	-	-	-	-	-	-	-

Climbing radius for the balancing weights

8033.16	Jib length [m]						
	45	42.5	40	37.5	35	32.5	30
no weight	-	-	-	-	-	-	-
TV 20 = 2.98 t	38.7	-	-	-	-	-	-
Weight = 5.0 t	26.0	27.7	26.4	26.7	28.1	-	-
Weight = 10.0 t	-	-	-	-	-	16.6	16.1

9 Suitable climbing devices

9.1.2 Outer climbing device KWH 23 / KWH 23.1

	NOTICE
	<p>Climbing radiuses marked with *</p> <p>Jib lengths marked with * can only be climbed with additional ballast. Please contact WOLFFKRAN for information.</p>

	NOTICE
	<p>Usage of KWH 23 on WOLFF 8033 with TV 20 lower part of tower head section</p> <p>You must use a joining frame VR 2023 to operate the outer climbing device KWH 23 in connection with the WOLFF 8033 on TV 20 tower head section lower part.</p>

Climbing radius 8033.8 cross

Climbing radius for the balancing weights, lower part of tower head section TV 20 with outer climbing device

8033.8	Jib length [m]						
	80	77.5	75	72.5	70	67.5	65
no weight	*	*	-	-	-	-	-
TV 23 = 3.04 t	-	-	14.9	22.8	21.7	23.8	23.0
Weight = 5.0 t	-	-	9.5	14.8	14.1	15.5	14.9
Weight = 10.0 t	-	-	-	-	-	-	-

Climbing radius for the balancing weights, lower part of tower head section TV 20 with outer climbing device

8033.8	Jib length [m]						
	62.5	60	57.5	55	52.5	50	47.5
no weight	-	-	-	-	-	-	-
TV 23 = 3.04 t	30.3	28.8	34.0	37.5	35.5	39.1	37.8
Weight = 5.0 t	19.8	18.8	22.3	24.7	23.3	25.8	24.8
Weight = 10.0 t	-	-	-	-	-	-	-

Climbing radius for the balancing weights, lower part of tower head section TV 20 with outer climbing device

8033.8	Jib length [m]						
	45	42.5	40	37.5	35	32.5	30
no weight	-	-	-	-	-	-	-
TV 23 = 3.04 t	36.4	-	-	-	-	-	-
Weight = 5.0 t	23.9	25.8	24.5	24.8	26.3	29.1	-
Weight = 10.0 t	-	-	-	-	-	15.2	14.7

Climbing radius for the balancing weights, lower part of tower head section HT 23 with outer climbing device

8033.8	Jib length [m]						
	80	77.5	75	72.5	70	67.5	65
no weight	*	*	-	-	-	-	-
HT 23 = 3.94 t	-	-	11.3	17.8	17.0	18.6	17.9
Weight = 5.0 t	-	-	9.1	14.4	13.7	15.1	14.5
Weight = 10.0 t	-	-	-	-	-	-	-

Climbing radius for the balancing weights, lower part of tower head section HT 23 with outer climbing device

8033.8	Jib length [m]						
	62.5	60	57.5	55	52.5	50	47.5
no weight	-	-	-	-	-	-	-
HT 23 = 3.94 t	23.9	22.7	27.0	29.8	28.1	31.1	30.0
Weight = 5.0 t	19.4	18.4	21.9	24.2	22.9	25.3	24.4
Weight = 10.0 t	-	-	-	-	-	-	-

Climbing radius for the balancing weights, lower part of tower head section HT 23 with outer climbing device

8033.8	Jib length [m]						
	45	42.5	40	37.5	35	32.5	30
no weight	-	-	-	-	-	-	-
HT 23 = 3.94 t	28.9	31.2	29.5	30.0	-	-	-
Weight = 5.0 t	23.5	25.4	24.0	24.4	25.9	-	-
Weight = 10.0 t	-	-	-	-	-	15.0	14.5

9 Suitable climbing devices

Climbing radius 8033.16 cross

Climbing radius for the balancing weights, lower part of tower head section TV 20 with outer climbing device

8033.16	Jib length [m]						
	80	77.5	75	72.5	70	67.5	65
no weight	*	*	46.8	-	-	-	-
TV 23 = 3.04 t	-	-	13.4	20.6	19.6	21.5	20.7
Weight = 5.0 t	-	-	8.8	13.8	13.1	14.4	13.9
Weight = 10.0 t	-	-	-	-	-	-	-

Climbing radius for the balancing weights, lower part of tower head section TV 20 with outer climbing device

8033.16	Jib length [m]						
	62.5	60	57.5	55	52.5	50	47.5
no weight	-	-	-	-	-	-	-
TV 23 = 3.04 t	27.4	26.0	30.8	33.9	32.1	35.4	34.2
Weight = 5.0 t	18.5	17.6	20.8	23.0	21.7	24.1	23.2
Weight = 10.0 t	-	-	-	-	-	-	-

Climbing radius for the balancing weights, lower part of tower head section TV 20 with outer climbing device

8033.16	Jib length [m]						
	45	42.5	40	37.5	35	32.5	30
no weight	-	-	-	-	-	-	-
TV 23 = 3.04 t	33.0	35.5	33.7	-	-	-	-
Weight = 5.0 t	22.3	24.1	22.8	23.1	24.5	27.2	26.4
Weight = 10.0 t	-	-	-	-	-	-	14.1

Climbing radius for the balancing weights, lower part of tower head section HT 23 with outer climbing device

8033.16	Jib length [m]						
	80	77.5	75	72.5	70	67.5	65
no weight	*	*	45.0	-	-	-	-
HT 23 = 3.94 t	-	-	10.4	16.4	15.6	17.1	16.5
Weight = 5.0 t	-	-	8.4	13.4	12.7	14.0	13.5
Weight = 10.0 t	-	-	-	-	-	-	-

Climbing radius for the balancing weights, lower part of tower head section HT 23 with outer climbing device

8033.16	Jib length [m]						
	62.5	60	57.5	55	52.5	50	47.5
no weight	-	-	-	-	-	-	-
HT 23 = 3.94 t	22.0	20.9	24.8	27.4	25.9	28.7	27.6
Weight = 5.0 t	18.1	17.2	20.4	22.6	21.3	23.7	22.8
Weight = 10.0 t	-	-	-	-	-	-	-

Climbing radius for the balancing weights, lower part of tower head section HT 23 with outer climbing device

8033.16	Jib length [m]						
	45	42.5	40	37.5	35	32.5	30
no weight	-	-	-	-	-	-	-
HT 23 = 3.94 t	26.6	28.7	27.2	27.6	29.3	-	-
Weight = 5.0 t	21.9	23.7	22.4	22.7	24.1	26.8	-
Weight = 10.0 t	-	-	-	-	-	-	13.9

9 Suitable climbing devices

9.2 Inner climbing devices

	NOTICE
	The data required and the instructions for tower assemblies with inner climbing device is available in the separate description of the inner climbing device.

DANGER! Observe the special tower combination for the inner climbing device.

	NOTICE
	Clamping forces for the inner climbing device (KSH) are specified based on a building height of < 250m and wind category C 25.

	NOTICE
	The listed climbing radius for the crane WOLFF 8033.16 cross only applies to the climbing procedure in 2 fall operation.

	NOTICE
	4 fall operation only with the 8033.16 cross. The 4 fall operation is only possible at the slewing tower crane 8033.16 cross.

9.2.1 Inner climbing device KSH 20 SH

Tower combinations for slewing tower cranes with inner climbing device.

Item				
1	TV 20.4	TV 20.4	TV 20.4	TV 20.4
2	TV 20.4	TV 20.4	TV 20.4	TV 20.4
3	TV 20.4	TV 20.4	TV 20.4	TV 20.4
4	TV 20.4	TV 20.4	TV 20.4	TV 20.4
5	TV 20.4	TV 20.4	TV 20.4	TV 20.4
6	TV 20.4	TV 20.4	TV 20.4	TV 20.4
7	TV 20.4	TV 20.4	TV 20.4	
8	TV 20.4	TV 20.4		
9	TV 20.4			
inner climbing device	KSH 20 SH	KSH 20 SH	KSH 20 SH	KSH 20 SH
Foundation	FUA TYPE FS-156 / FUA 156S	FUA TYPE FS-156 / FUA 156S	FUA TYPE FS-156 / FUA 156S	FUA TYPE FS-156 / FUA 156S
Tower height [m]	55.5	51.0	46.5	42.0
Hook height (2 fall operation) [m]	56.5	52.0	47.5	43.0
Hook height (4 fall operation) [m]	56.1	51.6	47.1	42.6

9 Suitable climbing devices

Climbing radius 8033.16 cross

Climbing radius [m] for the balancing weights

8033.16	Jib length [m]						
	80	77.5	75	72.5	70	67.5	65
TV 20.4 = 2.98 t	36.0	37.8	48.0	55.2	53.1	56.1	54.2
Weight = 5.0 t	24.5	25.8	32.7	37.6	36.2	38.2	37.0
Weight = 10.0 t	-	-	-	-	-	-	-

Climbing radius [m] for the balancing weights

8033.16	Jib length [m]						
	62.5	60	57.5	55	52.5	50	47.5
TV 20.4 = 2.98 t	-	-	-	-	-	-	-
Weight = 5.0 t	41.5	39.8	43.8	44.3	42.3	44.5	43.7
Weight = 10.0 t	-	-	-	-	-	-	-

Climbing radius [m] for the balancing weights

8033.16	Jib length [m]						
	45	42.5	40	37.5	35	32.5	30
TV 20.4 = 2.98 t	-	-	-	-	-	-	-
Weight = 5.0 t	42.1	-	-	-	-	-	-
Weight = 10.0 t	23.6	24.5	23.4	23.5	24.2	25.7	24.8

Climbing radius 8033.8 cross

Climbing radius [m] for the balancing weights

8033.8	Jib length [m]						
	80	77.5	75	72.5	70	67.5	65
TV 20.4 = 2.98 t	39.7	41.7	52.9	60.8	58.5	61.8	59.8
Weight = 5.0 t	26.2	27.5	34.9	40.1	38.6	40.8	39.5
Weight = 10.0 t	-	-	-	-	-	-	-

Climbing radius [m] for the balancing weights

8033.8	Jib length [m]						
	62.5	60	57.5	55	52.5	50	47.5
TV 20.4 = 2.98 t	-	-	-	-	-	-	-
Weight = 5.0 t	44.2	42.5	46.7	47.2	45.1	-	-
Weight = 10.0 t	-	-	-	-	-	25.8	25.3

Climbing radius [m] for the balancing weights

8033.8	Jib length [m]						
	45	42.5	40	37.5	35	32.5	30
TV 20.4 = 2.98 t	-	-	-	-	-	-	-
Weight = 5.0 t	-	-	-	-	-	-	-
Weight = 10.0 t	24.4	25.4	24.2	24.4	25.1	26.6	25.7

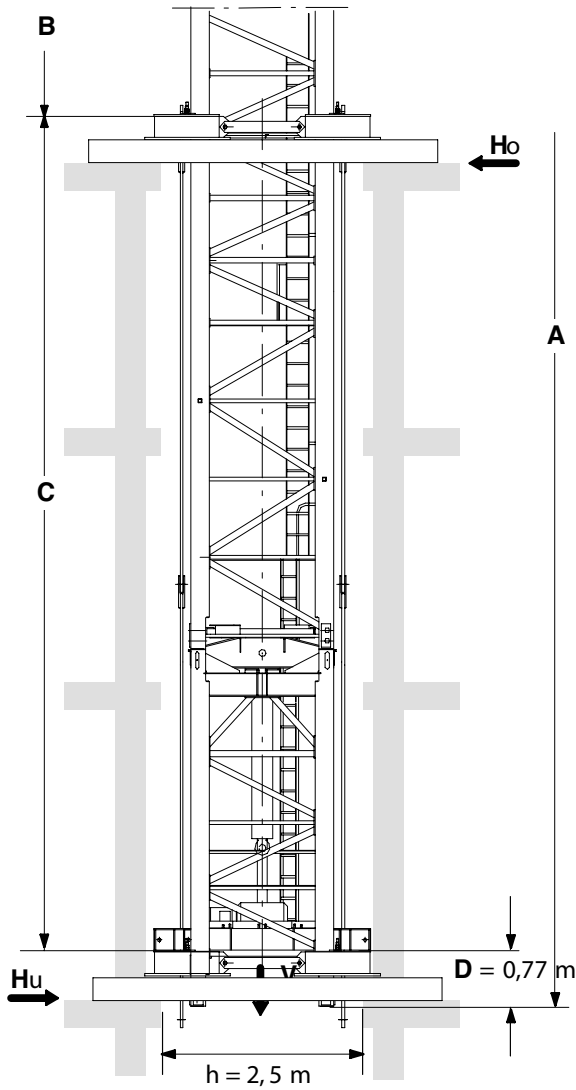

$$C_{\min} = 11,0 \text{ m}$$

$$C_{\max} = 14,0 \text{ m}$$

$$H_o = \frac{M}{C} + H$$

$$H_u = H_o - H$$

$$T = \frac{M_D}{2 \times b}$$

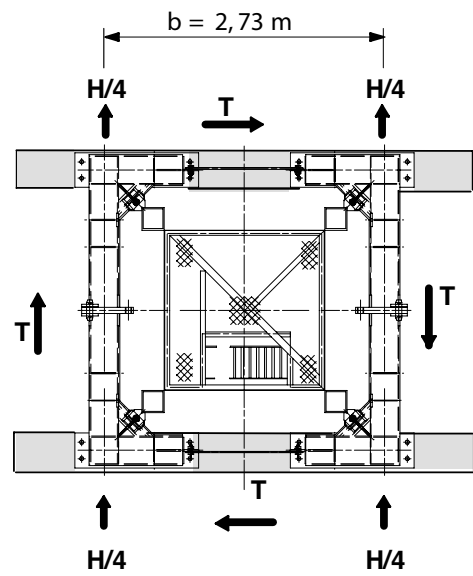

A	Tower height	C	Distance between guide frames
B	A-C-D		

9 Suitable climbing devices

In service clamping forces

In service clamping forces [kN] inside a building																
A [m]	55.5				51.0				46.5				42.0			
C [m]	11.0	12.0	13.0	14.0	11.0	12.0	13.0	14.0	11.0	12.0	13.0	14.0	11.0	12.0	13.0	14.0
V	1510				1481				1453				1425			
Ho	530	490	450	420	500	460	430	400	470	430	400	370	450	410	380	350
Hu	480	430	400	370	450	410	370	340	420	380	350	320	400	360	330	300
T	100				100				100				100			

Out of service clamping forces

Out of service clamping forces [kN] inside a building																
A [m]	55.5				51.0				46.5				42.0			
C [m]	11.0	12.0	13.0	14.0	11.0	12.0	13.0	14.0	11.0	12.0	13.0	14.0	11.0	12.0	13.0	14.0
V	1293				1265				1236				1208			
Ho	950	870	810	750	840	770	710	660	730	670	620	580	640	580	540	500
Hu	680	600	540	480	580	510	450	400	490	430	380	330	400	350	310	270
T	-				-				-				-			

9.2.2 Inner climbing device KSH 23/ KSH E 23

	NOTICE
	<p>Lower clamping length for the inner climbing device KSH 23 / KSH E 23.</p> <p>Subject to coordination with WOLFFKRAN, it is also possible to realize a clamping length of 10.0 to 15.5 m with a lower tower height. Contact WOLFFKRAN to discuss this option.</p>

Tower combinations 8033 cross, on lower part of tower head section HT 23 with inner climbing device

Item	Jib length 30 m - 80 m			
1	HT 23	HT 23	HT 23	HT 23
2	HT 23	HT 23	HT 23	HT 23
3	HT 23	HT 23	HT 23	HT 23
4	HT 23	HT 23	HT 23	HT 23
5	HT 23	HT 23	HT 23	HT 23
6	HT 23	HT 23	HT 23	HT 23
7	HT 23	HT 23	HT 23	HT 23
8	HT 23	HT 23	HT 23	HT 23
9	HT 23	HT 23	HT 23	HT 23
10	HT 23	HT 23	HT 23	
11	HT 23	HT 23		
12	HT 23			
inner climbing device	KSH E 23	KSH E 23	KSH E 23	KSH E 23
Foundation	FUA 210 G	FUA 210 G	FUA 210 G	FUA 210 G
Tower height [m]	70.5	66.0	61.5	57.0
Hook height [m] 2 fall operation	71.5	67.0	62.5	58.0
Hook height [m] 4 fall operation	71.1	66.6	62.1	57.6

9 Suitable climbing devices

Climbing radius 8033.8 cross

Climbing radius [m] for the balancing weights

8033.8	Jib length [m]						
	80	77.5	75	72.5	70	67.5	65
HT 23 = 3.94 t	31.9	33.5	42.5	48.8	47.0	49.7	48.0
Weight = 5.0 t	26.2	27.5	34.9	40.1	38.6	40.8	39.5
Weight = 10.0 t	-	-	-	-	-	-	-

Climbing radius [m] for the balancing weights

8033.8	Jib length [m]						
	62.5	60	57.5	55	52.5	50	47.5
HT 23 = 3.94 t	53.9	51.7	-	-	-	-	-
Weight = 5.0 t	44.2	42.5	46.7	47.2	45.1	-	-
Weight = 10.0 t	-	-	-	-	-	25.8	25.3

Climbing radius [m] for the balancing weights

8033.8	Jib length [m]						
	45	42.5	40	37.5	35	32.5	30
HT 23 = 3.94 t	-	-	-	-	-	-	-
Weight = 5.0 t	-	-	-	-	-	-	-
Weight = 10.0 t	24.4	25.4	24.2	24.4	25.1	26.6	25.7

Climbing radius 8033.16 cross

Climbing radius [m] for the balancing weights

8033.16	Jib length [m]						
	80	77.5	75	72.5	70	67.5	65
HT 23 = 3.94 t	29.5	30.9	39.3	45.1	43.4	45.9	44.4
Weight = 5.0 t	24.5	25.8	32.7	37.6	36.2	38.2	37.0
Weight = 10.0 t	-	-	-	-	-	-	-

Climbing radius [m] for the balancing weights

8033.16	Jib length [m]						
	62.5	60	57.5	55	52.5	50	47.5
HT 23 = 3.94 t	49.8	47.8	52.6	-	-	-	-
Weight = 5.0 t	41.5	39.8	43.8	44.3	42.3	44.5	43.7
Weight = 10.0 t	-	-	-	-	-	-	-

Climbing radius [m] for the balancing weights

8033.16	Jib length [m]						
	45	42.5	40	37.5	35	32.5	30
HT 23 = 3.94 t	-	-	-	-	-	-	-
Weight = 5.0 t	-	-	-	-	-	-	-
Weight = 10.0 t	23.6	24.5	23.4	23.5	24.2	25.7	24.8

9 Suitable climbing devices

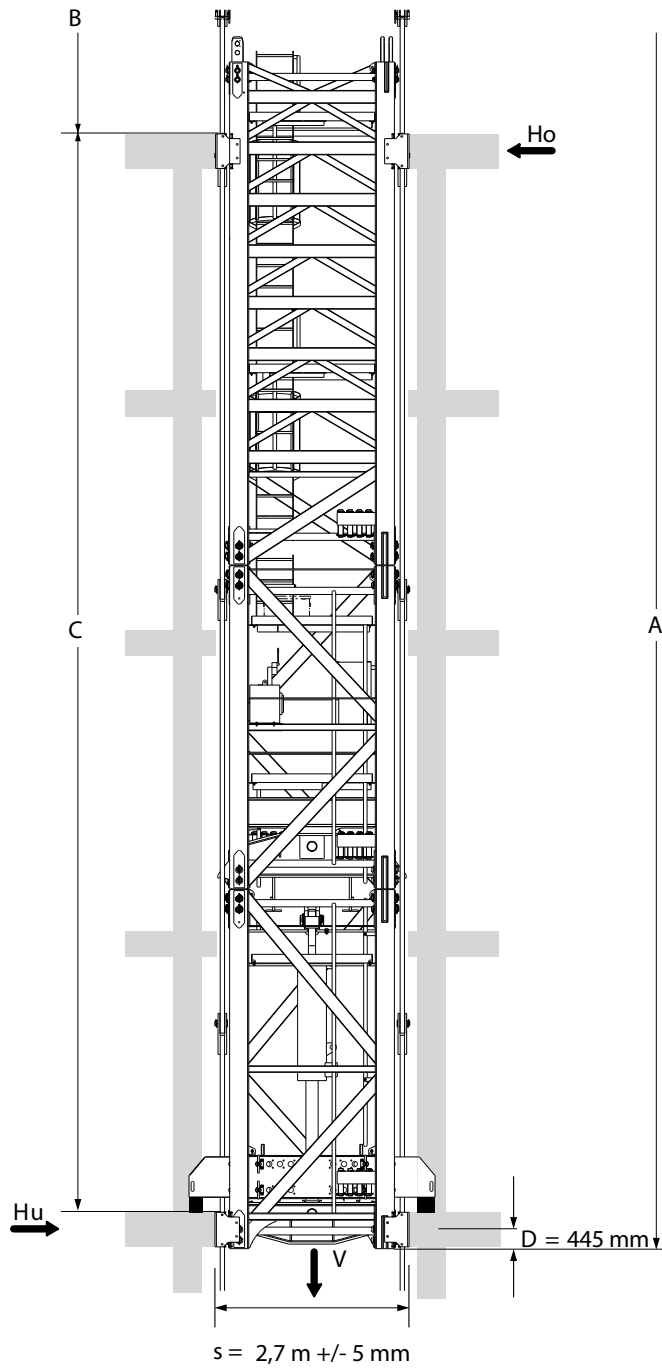

$$C_{\min} = 12,0 \text{ m}$$

$$C_{\max} = 15,5 \text{ m}$$

$$H_o = \frac{M}{C} + H$$

$$H_u = H_o - H$$

$$T = \frac{M_D}{2 \times b}$$

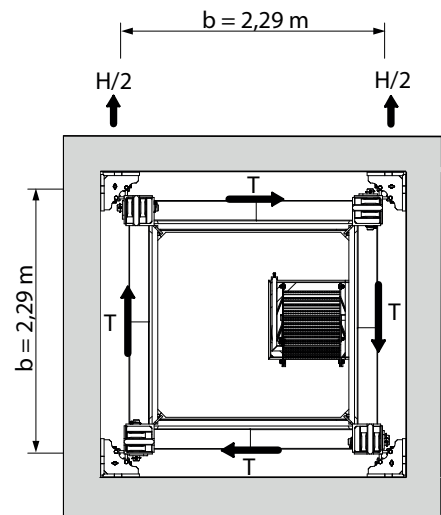

KSH E 23

A	= Tower height	C	= Distance between corner guides
B	= A-C-D		

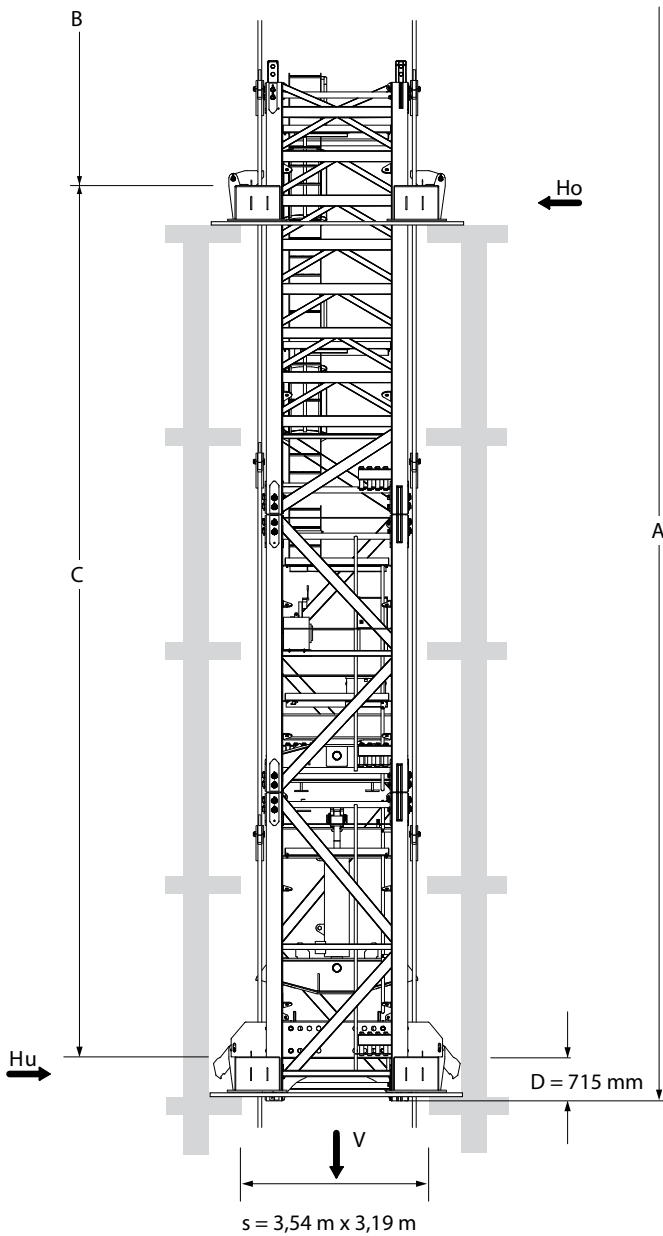

$$C_{\min} = 12,0 \text{ m}$$

$$C_{\max} = 15,5 \text{ m}$$

$$H_o = \frac{M}{C} + H$$

$$H_u = H_o - H$$

$$T = \frac{M_D}{2 \times b}$$

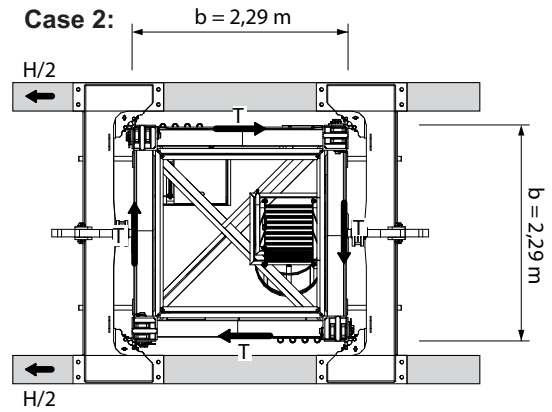
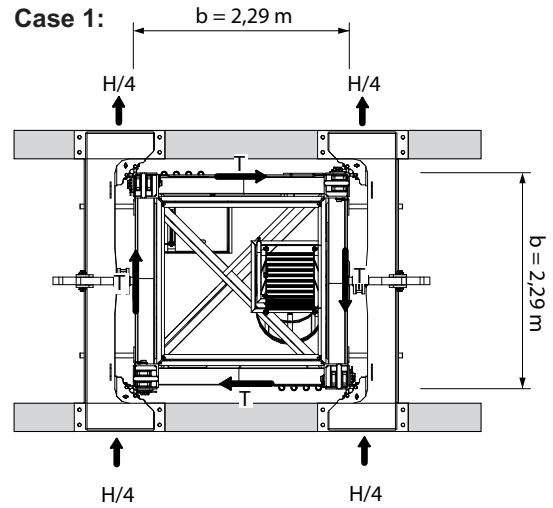

KSH 23

A	= Tower height	C	= Distance between climbing frames
B	= A-C-D		

9 Suitable climbing devices

In service clamping forces



In service clamping forces [kN] inside a building																				
A (m)	70.5					66.0					61.5					57.0				
C (m)	12.0	13.0	14.0	15.0	15.5	12.0	13.0	14.0	15.0	15.5	12.0	13.0	14.0	15.0	15.5	12.0	13.0	14.0	15.0	15.5
V (kN)	1936					1897					1857					1818				
Ho (kN)	580	540	500	470	450	550	510	470	440	430	520	480	440	410	400	490	450	420	390	380
Hu (kN)	510	470	430	400	380	480	440	410	370	360	450	420	380	350	340	430	390	360	330	320
T (kN)	110					110					110					110				

Out of service clamping forces

Out of service clamping forces [kN] inside a building																				
A (m)	70.5					66.0					61.5					57.0				
C (m)	12.0	13.0	14.0	15.0	15.5	12.0	13.0	14.0	15.0	15.5	12.0	13.0	14.0	15.0	15.5	12.0	13.0	14.0	15.0	15.5
V (kN)	1720					1680					1641					1601				
Ho (kN)	1330	1220	1140	1060	1030	1190	1100	1020	950	920	1070	990	920	850	830	950	880	810	760	740
Hu (kN)	980	880	790	720	680	860	770	690	620	590	750	670	600	540	510	650	570	510	460	430
T (kN)	-					-					-					-				

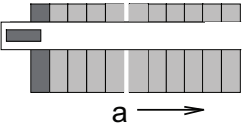
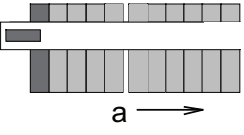
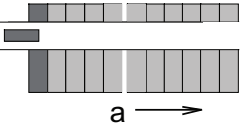
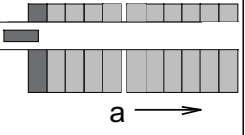
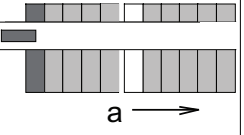
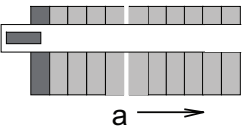
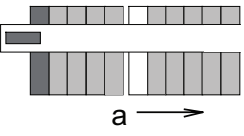
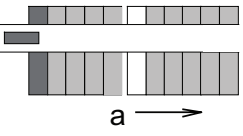
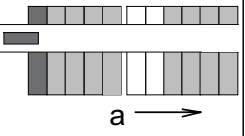
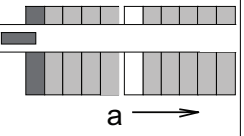
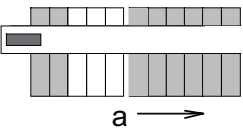
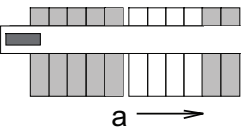
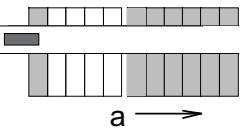
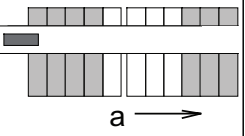
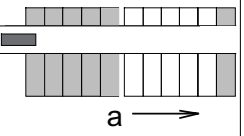
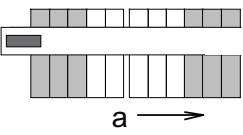
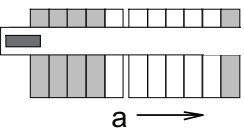
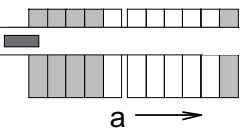
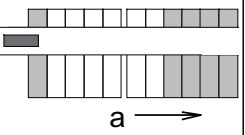
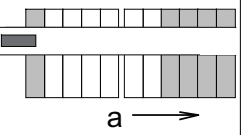
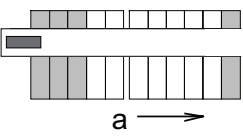
10 Arrangement of counterweight blocks

L = 80 m	L = 77.5 m	L = 75 m	L = 72.5 m	L = 70 m
11 x 2.7 t	11 x 2.7 t	11 x 2.7 t	11 x 2.7 t	10 x 2.7 t
				
W = 32.7 t	W = 32.7 t	W = 32.7 t	W = 32.7 t	W = 30.0 t
Additional permanent counterweight for all jib lengths: 3.0 t				
L = 67.5 m	L = 65 m	L = 62.5 m	L = 60 m	L = 57.5 m
11 x 2.7 t	10 x 2.7 t	10 x 2.7 t	9 x 2.7 t	10 x 2.7 t
				
W = 32.7 t	W = 30.0 t	W = 30.0 t	W = 27.3 t	W = 30.0 t
Additional permanent counterweight for all jib lengths: 3.0 t				
L = 55 m	L = 52.5 m	L = 50 m	L = 47.5 m	L = 45 m
8 x 2.7 t	7 x 2.7 t	7 x 2.7 t	7 x 2.7 t	6 x 2.7 t
				
W = 24.6 t	W = 21.9 t	W = 21.9 t	W = 21.9 t	W = 19.2 t
Additional permanent counterweight for all jib lengths: 3.0 t				
L = 42.5 m	L = 40 m	L = 37.5 m	L = 35 m	L = 32.5 m
6 x 2.7 t	5 x 2.7 t	5 x 2.7 t	5 x 2.7 t	5 x 2.7 t
				
W = 19.2 t	W = 16.5 t	W = 16.5 t	W = 16.5 t	W = 16.5 t
Additional permanent counterweight for all jib lengths: 3.0 t				
L = 30 m				
4 x 2.7 t				
				
W = 13.8 t				

	Intermediate ballast 1 x 2.7 t		Counterweight block 1 x 2.7 t
---	--------------------------------	---	-------------------------------

10 Arrangement of counterweight blocks

□	No counterweight	L	Jib length [m]
a	To the tower	G	Total weight [t]

WOLFFKRAN Group

Headquarter international:

WOLFFKRAN AG

Baarermattstraße 6

CH-6300 Zug

Switzerland

Phone +41 41 766 85 00

Fax +41 41 766 85 99

info@wolffkran.com

Manufacturing:

WOLFFKRAN GmbH

Austraße 72

D-74076 Heilbronn

Germany

Phone + 49 7131 9815 0

Fax + 49 7131 9815 355

info@wolffkran.de

WOLFFKRAN Werk Brandenburg GmbH

Frederik-Ipsen-Straße 5

D-15926 Luckau OT Alverno

Germany

Phone + 49 35456 674 0

Fax + 49 35456 674 200

info@wolffkran.de